

## 深圳市安腾照明有限公司

地址：深圳市龙华区观澜街道君子布社区环观南路10号八方智谷产业园G栋6楼

邮编：518110

邮箱：info@ants-led.com ; info@smacxty.com

网址：www.ants-led.com ; www.smacxty.com

## Ants Electronics Limited

Add : 6th Floor, Building G, Bafang Zhigu Industrial Park, No. 10, Huanguan South Road, Junzibu Community, Guanlan Street, Longhua District, Shenzhen

Post: 518110

Mail: info@ants-led.com ; info@smacxty.com

Web: www.ants-led.com ; www.smacxty.com



ANTSUIT  
— 安量 —

Work like an ant!



ANTSLIT  
— 安量 —

# The Brand Story

## Ants team working like the ant

### 公司简介 COMPANY PROFILE

Founded in 2008 and headquartered in Shenzhen, ANTS ELECTRONICS LIMITED (ANTSLIT) is a professional manufacturer specializing in roadway lighting design, development, production, and testing.

We hold certifications such as ISO9001:2015, ISO14001:2015, and others for quality, environmental management, and intellectual property management systems. With over 15 years of experience in roadway lighting solutions, we offer five series of products tailored for your roadway lighting projects: 1.HID Lamp Replacements: Including LED corn bulbs and replacement lamps. 2.LED Street Lighting: Main roadway LED streetlights, secondary roadway LED streetlights, courtyard LED lights, and more. 3.LED Solar Lighting: LED solar streetlights and solar courtyard lights. 4.Streetlight IoT Solutions: Featuring the SMACXTY smart streetlight illumination system with related sensors and controllers. 5.Customized Lighting: Providing custom unique lighting solutions to ensure your unique competitiveness. We understand that lighting fixtures must be practical, cost-effective, and reliable, which is why we prioritize customer-centric product design and development. ANTSLIT is a company that never rests when it comes to products and services.

深圳市安量照明有限公司 (ANTS ELECTRONICS LIMITED, 简称 ANTSLIT) 成立于2008年, 位于深圳, 是一家专业制造商, 专注于道路照明的设计、开发、生产和测试。我们已获得ISO9001:2015、ISO14001:2015等一系列质量、环境管理和知识产权管理体系的认证。

凭借超过15年的道路照明解决方案经验, 我们为道路照明项目提供了五个系列的定制产品方案:

- 1.HID灯海替换: 包括LED玉米灯和替代灯具。
- 2.LED路灯照明: 主干道LED路灯, 次要道路LED路灯, 庭院LED灯等。
- 3.LED太阳能照明: LED太阳能路灯和太阳能庭院灯。
- 4.智能路灯解决方案: 配备SMACXTY智能路灯照明系统, 包括相关的传感器和控制器。
- 5.定制照明: 提供定制的特殊照明解决方案, 确保您独特的竞争力。我们深刻理解照明设备必须实用、成本效益且可靠, 因此我们将客户为中心的产品设计和开发置于首位。

ANTSLIT是一家在产品和服务方面永不停歇的公司。

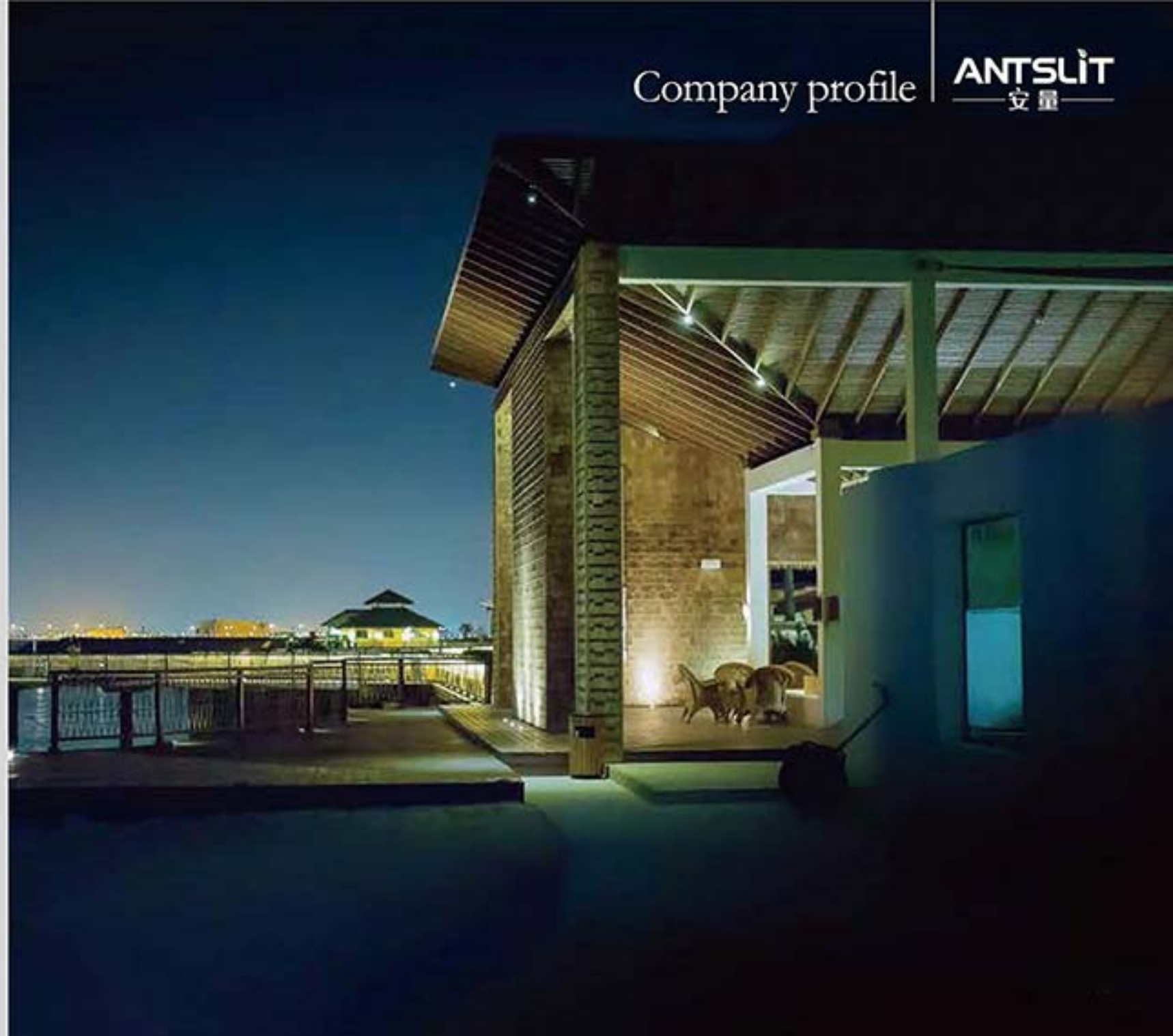

# PRODUCTS CONTENTS

@ANTSLIT  
— 丈量 —



替换光源  
HID replacement

LED 路灯  
LED street light

智慧照明  
Smart lighting

太阳能照明  
Solar lighting

定制照明  
Customized Lighting

Products contents

ANTSLIT  
— 丈量 —

Work like an ant!

# 替换光源

HID replacement

## 系列介绍 Series Introduction

主要应用于HID、HPS、CFL、MHL、HQL等老旧灯具的替换，螺口安装设计，使用方便、快捷，并保持原有的灯壳，不破坏原有的配光设计！安全，节能，经济的led产品！

Mainly used in the replacement of old lamps such as HID, HPS, CFL, MHL, HQL screw mounting design, easy to use, fast, and keep the original lamp housing, without destroying the original light distribution design! Safe, energy saving, and economical LED product!





## AT-WYX01 \*\*R

Countryside road, 35w to 80w led bulbs replace 100w to 175w HID  
Auxiliary road, 100w to 175w led bulbs replace 175w to 250w HID  
Highway main road, 250w to 450w led bulbs replace 400w to 1000w HID

## REPLACEMENT LED LIGHTS SERIES

@LED替换光源系列

### AT-WYX01\*\*R HID REPLACEMENT LED BULBS

100% Encloed Fixture

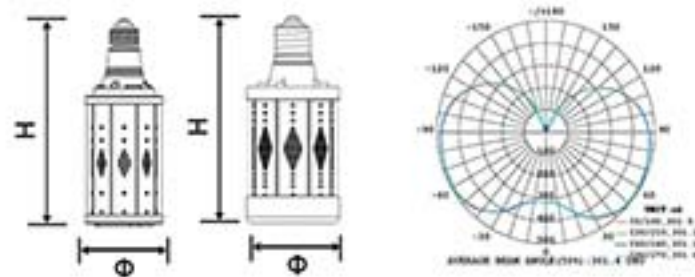

Item No.: AT-WYX01-35R/50R/80R/100R/125R/175R

Power: 35W/50W/80W/100W/125W/150W/175W

Efficiency: 175lm/w-185lm/w

LED chips: Epistar2835

Size: Φ70\*175mm / Φ70\*195mm / Φ70\*205mm / Φ100\*205mm

Base: E27/E26 E40/E39

CCT: 1800k-6500k

Dimming: Light sensor switch, microwave/IR sensor, 0/1-10V,DALI 2.0 D4I, PWM, Timer; 4G/LoraWan Smart Control



## AT-WYX01 \*\*

AT-WYX01 series LED Corn Light Series lamps use Rubycon driver intelligent temperature protection function, Philips chips, heat dissipation with aircraft grade aluminium, IP54 damp location-rated design, dust-proof, mosquito proof, driver is sealed with thermal paste, 360 degree beam angle, flame retardant materials, It can offer retrofit replacement for high watt HID lamp installations.

REPLACEMENT LED  
LIGHTS SERIES  
@LED替换光源系列

## AT-WYX01\*\* HID REPLACEMENT LED BULBS

100% Enclosed Fixture

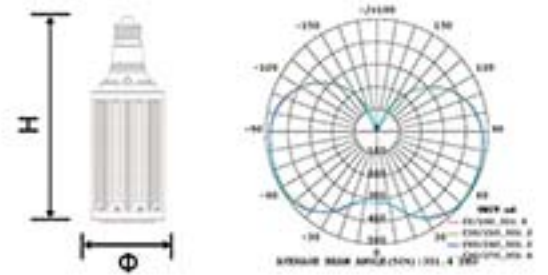

Item No.: AT-WYX01-24/35/50/80

- Power: 24W/35W/50W/80W
- Efficiency: 175lm/w-185lm/w
- LED chips: Epistar2835
- Size:  $\Phi 70 \times 135\text{mm}$  /  $\Phi 70 \times 175\text{mm}$  /  $\Phi 70 \times 195\text{mm}$  /  $\Phi 70 \times 205\text{mm}$
- Base: E27/E26 E40/E39
- Weight: 0.403kg 045kg 0.55kg
- CCT: 1800k-6500k
- Dimming: Light sensor switch, microwave/IR sensor, 0/1-10V,DALI 2.0 D4I, PWM, Timer; 4G/LoraWan Smart Control



## REPLACEMENT LED LIGHTS SERIES

@LED替换光源系列

### AT-WYX01-350 HID REPLACEMENT LED BULBS

100% Enclosed Fixture

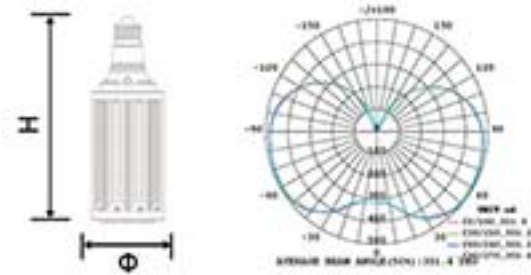

Item No.: AT-WYX01-350

Power: 350W  
Efficiency: 180lm/w  
LED chips: Philips SMD 3030  
Size:  $\Phi 100 \times 355$ mm  
Base: E27/E26 E40/E39  
Weight: 1.75kg  
CCT: 1800k-6500k  
Dimming: Light sensor switch, microwave/IR sensor, 0/1-10V, DALI 2.0 D4I, PWM, Timer; 4G/LoraWan Smart Control

**350W** super high wattage corn lamp  
Brightness equivalent to a 1000W HID light bulb  
Mainly plays an important role in the field of balloon floodlights





## AT-CON4

AT-CON4 series LED Corn Light Series lamps use Epistar chips, IP64 damplocation-rated design, waterproof, dust-proof, mosquito proof, driver is sealed with thermal paste, active heat dissipation with aircraft grade aluminum, 360 degree beam angle, flame retardant materials, suitable for use in totally enclosed fixtures. Direct wire lamps, must bypass the ballast.

REPLACEMENT LED  
LIGHTS SERIES

@LED替换光源系列

## AT-CON4 LED CORN LIGHT

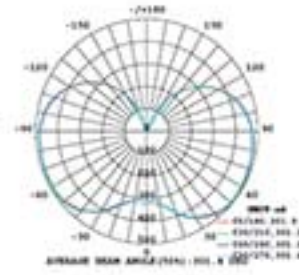
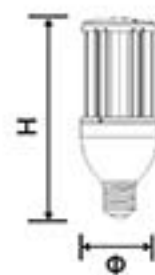

Item No.: AT-CON4-12/16/20/24

Power: 12W / 16W / 20W / 24W

Efficiency: 140lm/w

Size:  $\Phi 64 \times 157\text{mm}$  /  $\Phi 64 \times 167\text{mm}$  /  $\Phi 64 \times 187\text{mm}$  /  $\Phi 64 \times 207\text{mm}$

Base: E27/E26 E40/E39

CCT: 1800k-6500k

Dimming: Light sensor switch, microwave/IR sensor, 0/1-10V, DALI 2.0 D4I, PWM, Timer; 4G/LoraWan Smart Control



## AT-CON5

AT-CON5 series LED Corn Light Series lamps use Rubycon driver, Epistar chips, IP65 damp location-rated design, waterproof, dust-proof, mosquito proof, driver is sealed with thermal paste, active heat dissipation with aircraft grade aluminum, 360 degree beam angle, flame retardant materials, suitable for use in totally enclosed fixtures. Direct wire lamps, must bypass the ballast.

## REPLACEMENT LED LIGHTS SERIES

@LED替换光源系列

### AT-CON5 LED CORN LIGHT

IP65 waterproof

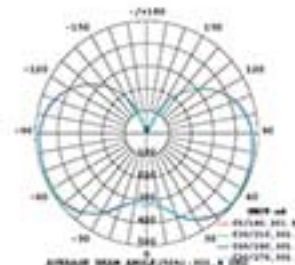
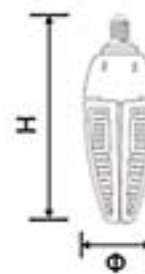

Item No.: AT-CON5-30/40/50

Power: 30W / 40W / 50W

Efficiency: 140lm/w

Size:  $\Phi 88 \times 258$ mm

Base: E27/E26 E40/E39

CCT: 1800k-6500k

Dimming: Light sensor switch, microwave/IR sensor, 0/1-10V, DALI 2.0 D4I, PWM, Timer; 4G/LoraWan Smart Control



AT-CON9

Eliminate Light Pollution with the AT-CON9 friendly LED HID Post Top Retrofit Lamp Series. This lamp is designed for post top applications in dark sky friendly cities and neighborhoods. All of the light is directed downwards; no light escapes into the night sky.

REPLACEMENT LED  
LIGHTS SERIES

@LED替换光源系列

## AT-CON9 LED CORN LIGHT

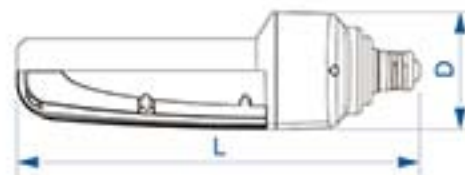

Item No.:AT-CON9-36/45/54

Power: 36w / 45w / 54w

Efficiency: 140lm/w

Size:  $\varnothing 98 \times 242$ mm

Base: E26/E27 E39/E40

CCT: 1800K-6500K

Dimming: Light sensor switch, microwave/IR sensor, 0/1-10V, DALI 2.0 D4I, PWM, Timer, 4G/LoraWan Smart Control



AT-CON1B



REPLACEMENT LED  
LIGHTS SERIES

@LED替换光源系列

## AT-CON1B LED CORN LIGHT

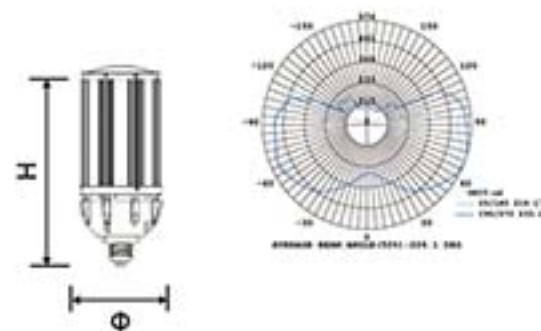

Item No.:AT-CON1B-27/36/45/54

Power: 27w / 36w / 45w / 54w

Efficiency: 140lm/w

Size:  $\Phi 93 \times 93 \times 204\text{mm}$  /  $\Phi 93 \times 93 \times 234\text{mm}$  /  $\Phi 93 \times 93 \times 265\text{mm}$  /  $\Phi 93 \times 93 \times 275\text{mm}$

Base: E26/E27 E39/E40

CCT: 1800K-6500K

Dimming: Light sensor switch, microwave/IR sensor, 0/1-10V,DALI 2.0 D4I, PWM, Timer; 4G/LoraWan Smart Control



REPLACEMENT LED  
LIGHTS SERIES

@LED替换光源系列

## AT-CON6 LED CORN LIGHT

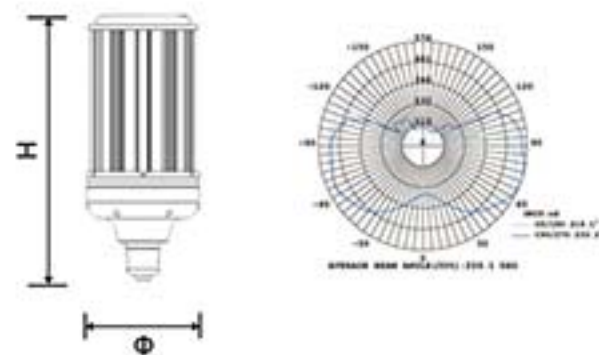

Item No.:AT-CON6-80/100/120/140

Power: 80w / 100w / 120w / 140w

Efficiency: 140lm/w

Size:  $\Phi 133 \times 262\text{mm}$  /  $\Phi 133 \times 282\text{mm}$  /  $\Phi 133 \times 302\text{mm}$  /  $\Phi 133 \times 341\text{mm}$

Base: E26/E27 E39/E40

CCT: 1800K-6500K

Dimming: Light sensor switch, microwave/IR sensor, 0/1-10V,DALI 2.0 D4I, PWM, Timer; 4G/LoraWan Smart Control



REPLACEMENT LED  
LIGHTS SERIES

@LED替换光源系列

## AT-CON1D LED CORN LIGHT

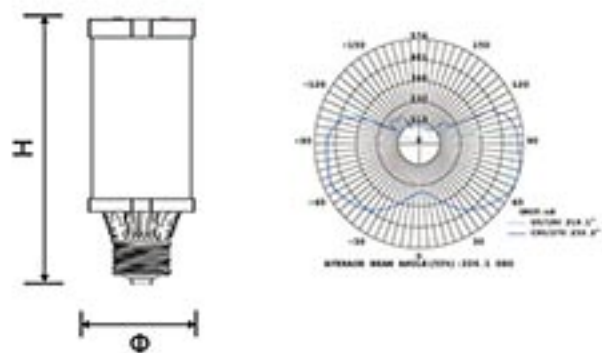

**Item No.:AT-CON1D-10/24/30**

Power: 10w / 24w / 30w

Efficiency: 150lm/w

Size:  $\Phi 53.5 \times 1135$ mm

Base: E26/E27 E39/E40

CCT: 1800K-6500K

Dimming: Light sensor switch, microwave/IR sensor, 0/1-10V,DALI 2.0 D4I, PWM, Timer; 4G/LoraWan Smart Control



REPLACEMENT LED  
LIGHTS SERIES

@LED替换光源系列

## AT-CON7C LED CORN LIGHT

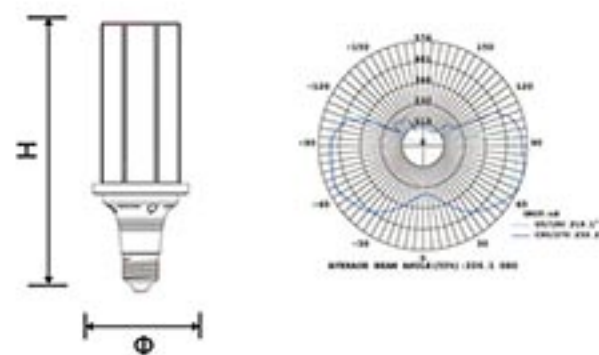

Item No.:AT-CON7C-25/35/45/55

Power: 25w / 35w / 45w / 55w

Efficiency: 150lm/w

Size:  $\Phi 70 \times 168\text{mm}$  /  $\Phi 70 \times 168\text{mm}$  /  $\Phi 70 \times 198\text{mm}$  /  $\Phi 70 \times 198\text{mm}$

Base: E26/E27 E39/E40

CCT: 1800K-6500K

Dimming: Light sensor switch, microwave/IR sensor, 0/1-10V,DALI 2.0 D4I, PWM, Timer; 4G/LoraWan Smart Control



REPLACEMENT LED  
LIGHTS SERIES

@LED替换光源系列

## AT-SOX LED CORN LIGHT

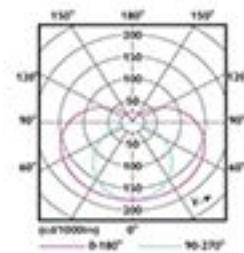
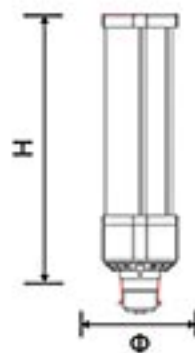

**Item No.:AT-SOX-16/24/36/72/120**

Power: 16w / 24w / 36w / 72w / 120w

Efficiency: 150lm/w - 180lm/w

Size:  $\Phi 53.5 \times 216\text{mm}$  /  $\Phi 53.5 \times 311\text{mm}$  /  $\Phi 53.5 \times 425\text{mm}$  /  $\Phi 53.5 \times 525\text{mm}$  /  $\Phi 53.5 \times 765\text{mm}$

Base: E26/E27 E39/E40

CCT: 1800K-6500K

Dimming: Light sensor switch, microwave/IR sensor, 0/1-10V,DALI 2.0 D4I, PWM, Timer; 4G/LoraWan Smart Control





# HERITAGE LED RETROFIT KIT

LIGHTS SERIES

@LED替换光源系列

## AT-RKC LED

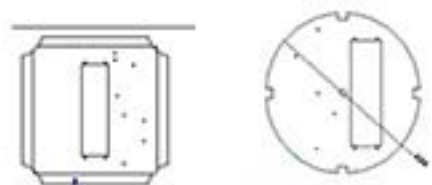

### Professional optics



EDNA STANDARD	Beamwidth width - mounting height	
	One side mounting	Both side mounting
Type I	Up to 1 beam 50%	Up to 2 beam 50%
Type II	Up to 1.5 beam 50%	Up to 3 beam 50%
Type III	Up to 2 beam 50%	Up to 4 beam 50%
Type IV	Up to 4 beam 50%	

**Item No.:AT-RKC LED-20/30/40/50/60/70/80/100**

Power: 20w / 30w / 40w / 50w / 60w / 70w / 80w / 100w

Efficiency: 110lm/w-160lm/w

LED chips: Philips 3030

Lens: T1M,T2M,T3M,T4S

CCT: 1800k-6500k

Dimming: Light sensor switch, microwave/IR sensor, 0/1-10V,DALI 2.0 D4I, PWM, Timer; 4G/LoraWan Smart Control

Size: Customization





HERITAGE LED RETROFIT KIT  
LIGHTS SERIES  
@LED替换光源系列

AT-RKS LED

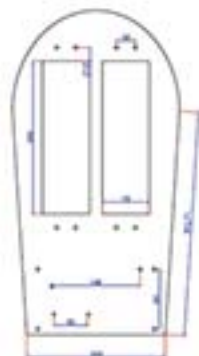

Professional optics



IESNA STANDARD	Beamwidth width / Mounting height	
	One side mounting	Both side mounting
Type I	Up to 1.5 times MH	Up to 2 times MH
Type II	Up to 1.5 times MH	Up to 3 times MH
Type III	Up to 2 times MH	Up to 4 times MH
Type IV	Up to 2 times MH	Up to 4 times MH
Type V	Up to 4 times MH	



Item No.:AT-RKS LED-20/30/50/80/100/120/150/180/200/240

Power: 20w / 30w / 50w / 80w / 100w / 120w / 150w / 180w / 200w / 240w

Efficiency: 110lm/w-160lm/w

LED chips: Philips 3030

Lens: T1M,T2M,T3M,T4S

CCT: 1800k-6500k

Dimming: Light sensor switch, microwave/IR sensor, 0/1-10V,DALI 2.0 D4I, PWM, Timer; 4G/LoraWan Smart Control

Size: Customization



## AT-TWL

- 360°Omni-directional lighting.
- 4-6KV internal surge protection.
- Come with 6.5foot 18AWG cord and 120V plug.
- switch to change CCT 3000K 4500k 6000K Dimmable: 0 to100%
- Dimmable: 0 to100%
- Heavy duty and durable construction, steel stainless lamp cage.
- Portable hook, easy to carry and quick install.
- Isolated driver to ensure stable working situation.
- Waterproof rubber design for better waterproof performance.
- Operating temperature: -40°C/ - 40°F to 60°C/140°F. □

## REPLACEMENT LED LIGHTS SERIES

@LED替换光源系列

### AT-TWL-50W LED TEMPORARY WORK LIGHT

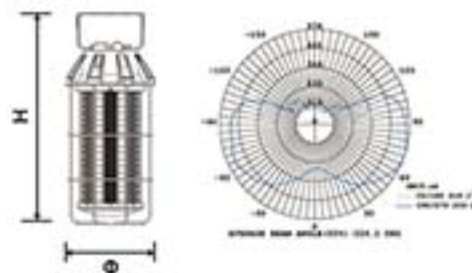

Dimmable

3000K

4500K

6000K

- ① Dimming switch  
Dimming(0-50watt) Power/Lux adjustable
- ② CCT adjustment switch  
(3000k/4500k/6000k)
- ③ Handle
- ④ 6.5ft/2m 120V 18AWG plug with cord

#### Item No.:AT-TWL-50W

Power: 50W  
 Efficiency: 110lm/w  
 LED chips: Epistar 2835  
 Size: Φ127\*277mm  
 Cable Length: 6.5ft/2m  
 CCT: 3000K/4500K/6000K adjustable 0-100% smooth dimmable  
 Four ways usage: Hook lifting/ Hand-Held/Flat Placing/Tripod Fixing  
 Cover: Milky/clearly



# LED 路灯

## LED STREET LIGHT

### 系列介绍 Series Introduction

产品应用涵盖城市道路、隧道、乡村道路，广场等；相比旧的照明灯具，led市政照明系列灯具具有更多的配光角度选择、外观设计更加精美、轻便、寿命长并可以节约75%以上的能源！

Product applications cover urban roads, tunnels, country roads, squares, etc. Compared to the old lighting fixtures, led municipal lighting series lamps have more choice of light distribution angle, more beautiful design, lighter, long life and it can save more than 75% Energy!

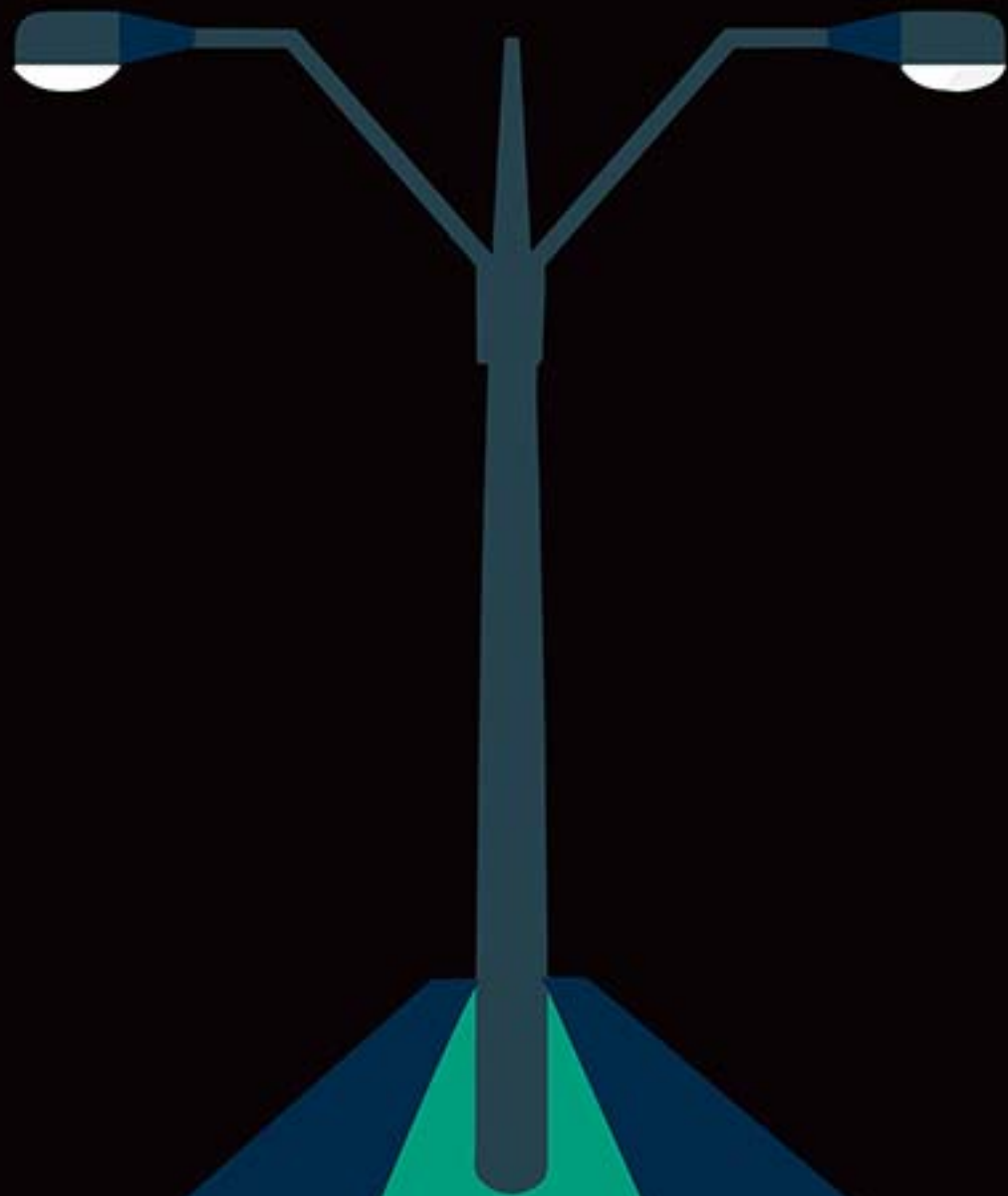



## LED STREET LIGHT SERIES @LED路灯系列

### AT-S05 LED STREET LIGHT

## North America

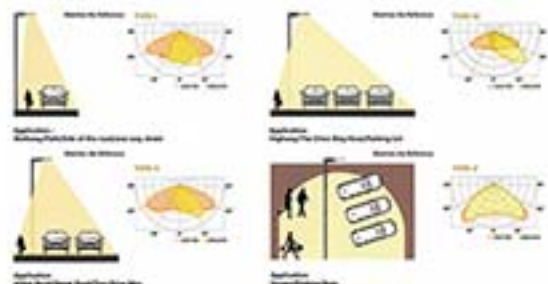

Item No.:AT-S05-100/150/200/240/300

Power: 100w / 150w / 200w / 240w / 300w

Efficiency: 150lm/w

Size: 595\*251\*70mm / 626\*281\*70mm / 699\*301\*70mm

Lens: T2M,T3M,T4S,T5

CCT: 1800K-6500K

Dimming: Light sensor switch, microwave/IR sensor, 0/1-10V,DALI 2.0 D4I, PWM, Timer; 4G/LoraWan Smart Control



## LED STREET LIGHT SERIES @LED路灯系列

### AT-S06 LED STREET LIGHT

## Europe

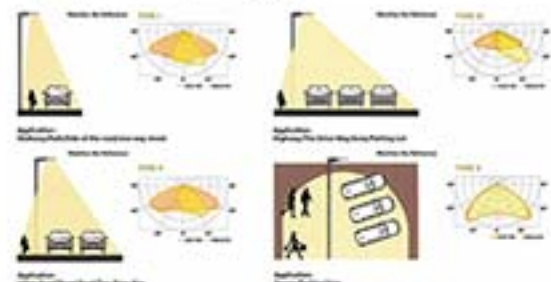
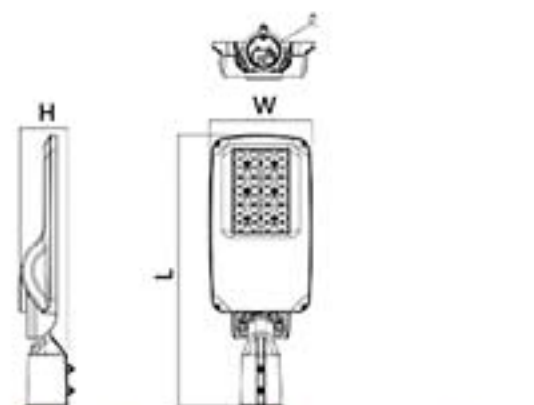

Item No.:AT-S06-50/75/80/100/120/150/180/200/240

Power: 50w / 75w / 80w / 100w / 120w / 150w / 180w / 200w / 240w

Efficiency: 155lm/w ; 160lm/w ; 165lm/w

Size: 467\*175\*75mm / 564\*221\*75mm / 647\*241\*75mm / 740\*276\*75mm

Lens: T1M,T2M,T3M,T4S

CCT: 1800K-6500K

Dimming: Light sensor switch, microwave/IR sensor, 0/1-10V,DALI 2.0 D4I, PWM, Timer; 4G/LoraWan Smart Control



LED STREET LIGHT  
SERIES  
@LED路灯系列

AT-S07 LED  
STREET LIGHT

Europe

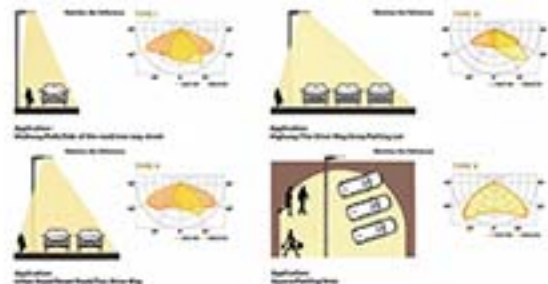
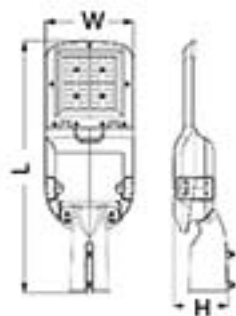

Item No.: AT-S07-30/50/60/75/80/100/120/150/180/200/240

Power: 30w / 50w / 60w / 75w / 80w / 100w / 120w / 150w / 180w / 200w / 240w

Efficiency: 120lm/w; 125lm/w; 130lm/w; 140lm/w; 150lm/w

Size: 493\*174\*108mm / 562\*200\*107mm

Lens: T1M, T2M, T3M, T4S

CCT: 1800K-6500K

Dimming: Light sensor switch, microwave/IR sensor, 0/1-10V, DALI 2.0 D4I, PWM, Timer; 4G/LoraWan Smart Control



LED STREET LIGHT  
SERIES  
@LED路灯系列

AT-S08 LED  
STREET LIGHT

Europe

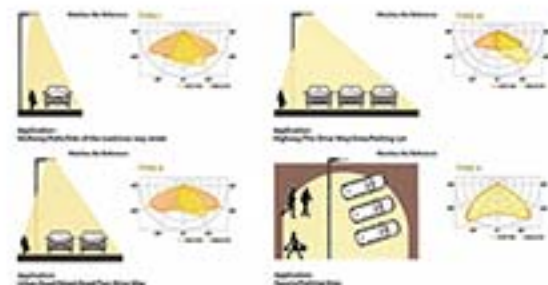

Item No.: AT-S08-50/75/80/100/120/150/180/200/240

Power: 50w / 75w / 80w / 100w / 120w / 150w / 180w / 200w / 240w

Efficiency: 130lm/w; 135lm/w; 140lm/w; 155lm/w; 160lm/w; 165lm/w

Size: 220\*515\*85mm / 220\*565\*85mm / 240\*635\*85mm / 290\*665\*85mm

Lens: T1M, T2M, T3M, T4S

CCT: 1800K-6500K

Dimming: Light sensor switch, microwave/IR sensor, 0/1-10V, DALI 2.0 D4I, PWM, Timer; 4G/LoraWan Smart Control





LED STREET LIGHT  
SERIES  
@LED路灯系列

AT-S09 LED  
STREET LIGHT

South America

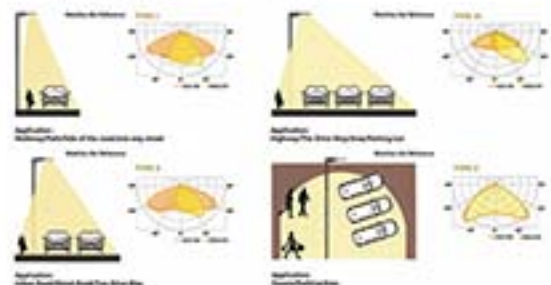
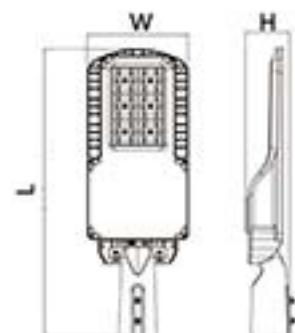

Item No.:AT-S09-25/50/60/75/80/100/120/150/180/200/240

Power: 30w / 50w / 60w / 75w / 80w / 100w / 120w / 150w / 180w / 200w / 240w

Efficiency: 120lm/w;125lm/w;130lm/w;135lm/w;145lm/w;150lm/w;165lm/w;170lm/w;175lm/w

Size: 463\*173\*87mm / 570\*200\*88mm / 611\*240\*89mm / 680\*260\*89mm / 693\*260\*90mm

Lens: T1M,T2M,T3M,T4S

CCT: 1800K-6500K

Dimming: Light sensor switch, microwave/IR sensor, 0/1-10V,DALI 2.0 D4I, PWM, Timer; 4G/LoraWan Smart Control



LED STREET LIGHT  
SERIES  
@LED路灯系列

AT-S10 LED  
STREET LIGHT

South America

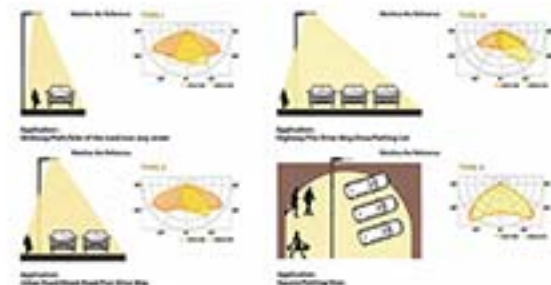
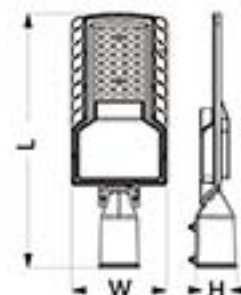

Item No.:AT-S10-25/40/50/75/80/100/120/150/180/200/240

Power: 25w / 40w / 50w / 75w / 80w / 100w / 120w / 150w / 180w / 200w / 240w

Efficiency: 175lm/w ; 180lm/w

Size: 438\*108\*75mm / 467\*175\*75mm / 564\*221\*75mm / 647\*241\*75mm / 740\*276\*75mm

Lens: T3M

CCT: 1800K-6500K

Dimming: Light sensor switch, microwave/IR sensor, 0/1-10V,DALI 2.0 D4I, PWM, Timer; 4G/LoraWan Smart Control



## LED STREET LIGHT SERIES @LED路灯系列

### AT-S11 LED STREET LIGHT

Asia/Africa

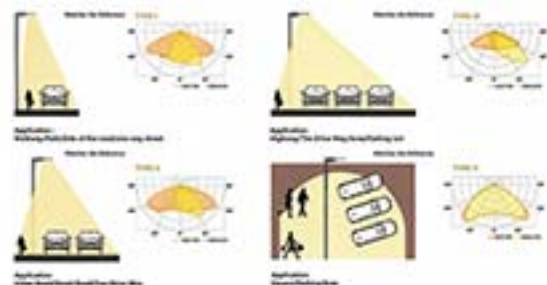

Item No.:AT-S11-50/100/150/200

Power: 50w / 100w / 150w / 200w

Efficiency: 130lm/w;135lm/w

Size: 467\*175\*75mm / 564\*221\*75mm / 647\*241\*75mm / 740\*276\*75mm

Lens: T2M

CCT: 1800K-6500K

Dimming: Light sensor switch, microwave/IR sensor, 0/1-10V,DALI 2.0 D4I, PWM, Timer; 4G/LoraWan Smart Control



## LED STREET LIGHT SERIES @LED路灯系列

### AT-S12 LED STREET LIGHT

Asia/Africa

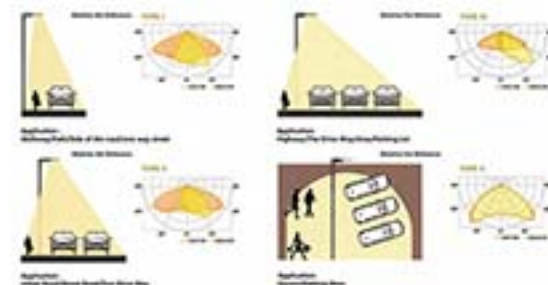

Item No.:AT-S12-20/30/50/60/80/100/120/150/180

Power: 20w / 30w / 50w / 60w / 80w / 100w / 120w / 150w / 180w

Efficiency: 110lm/w ; 115lm/w

Size: 315\*128\*76mm / 351\*142\*76mm / 405\*166\*79mm / 484\*211\*83mm / 580\*242\*83mm

Lens: T2M

CCT: 1800K-6500K

Dimming: Light sensor switch, microwave/IR sensor, 0/1-10V,DALI 2.0 D4I, PWM, Timer; 4G/LoraWan Smart Control





LED STREET LIGHT  
SERIES  
@LED路灯系列

AT-S13 LED  
STREET LIGHT

Asia/Africa



Item No.:AT-S13-50/60/100/120/150/180/200/240

Power: 50w / 60w / 100w / 120w / 150w / 180w / 200w / 240w

Efficiency: 130lm/w;160lm/w

Size: 503x169x86mm / 568x210x88mm / 659x250x88mm / 734x300x108mm

Lens: T2M

CCT: 1800K-6500K

Dimming: Light sensor switch, microwave/IR sensor, 0/1-10V,DALI 2.0 D4I, PWM, Timer; 4G/LoraWan Smart Control



LED STREET LIGHT  
SERIES  
@LED路灯系列

AT-S14 LED  
STREET LIGHT

Europe

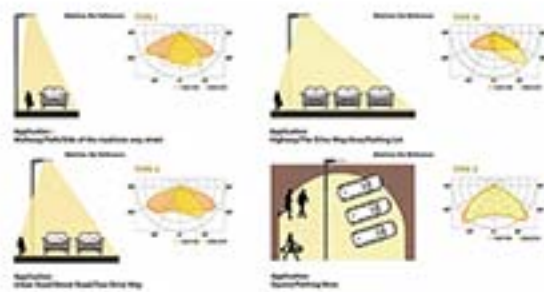

Item No.:AT-S14-50/80/100/120/150/180/200/240

Power: 50w / 80w / 100w / 120w / 150w / 180w / 200w / 240w

Efficiency: 140lm/w ; 160lm/w ; 180lm/w

Size: 640\*260\*115mm / 675\*260\*115mm / 790\*305\*115mm / 910\*305\*115mm

Len: T2/T3/T4/T5

CCT: 3000K-6000K

Dimming: Light sensor switch, microwave/IR sensor, 0/1-10V,DALI 2.0 D4I, PWM, Timer; 4G/LoraWan Smart Control



## LED STREET LIGHT SERIES @LED路灯系列

### AT-S0502 LED STREET LIGHT

### North America

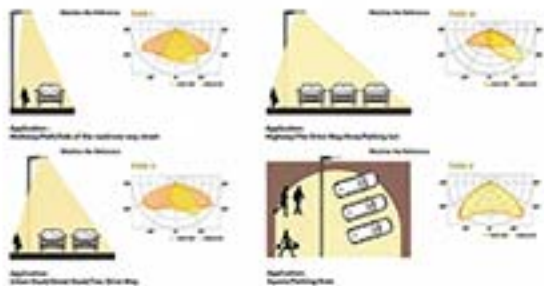
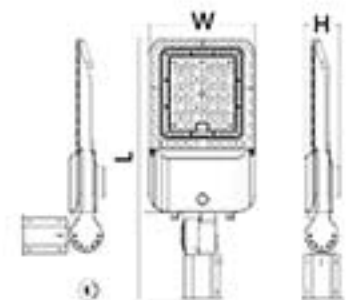

Item No.: AT-S0502-80/100/120/150/180/200/240/300

Power: 80w / 100w / 120w / 150w / 180w / 200w / 240w / 300w

Efficiency: 150lm/w ; 160lm/w

Size: 519\*210\*69mm / 565\*250\*70mm / 589\*280\*75mm / 674\*300\*80mm

Len: T2/T3/T4/T5

CCT: 1800K-6500K

Dimming: Light sensor switch, microwave/IR sensor, 0/1-10V, DALI 2.0 D4I, PWM, Timer; 4G/LoraWan Smart Control





LED STREET LIGHT  
SERIES  
@LED路灯系列

AT-SPC LED STREET LIGHT Eurpoe

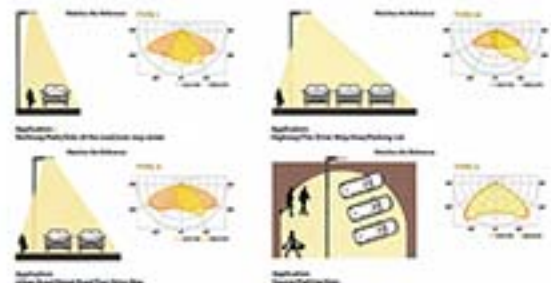
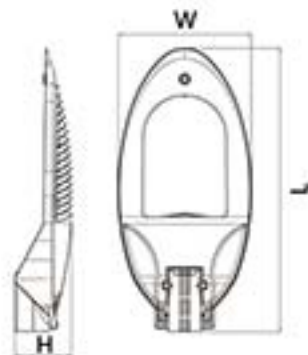

Item No.:AT-SPC-30/50/60/80/100/120/150/180

Power: 30w / 50w / 60w / 80w / 100w / 120w / 150w / 180w  
 Efficiency: 105lm/w;108lm/w;110lm/w  
 Size: 475\*238\*103mm / 646\*303\*129 mm / 863\*374\*172mm  
 Lens: T1M,T2M,T3M,T4S  
 CCT: 1800K-6500K  
 Dimming: Light sensor switch, microwave/IR sensor, 0/1-10V,DALI 2.0 D4I, PWM, Timer; 4G/LoraWan Smart Control



LED STREET LIGHT  
SERIES  
@LED路灯系列

AT-STL LED STREET LIGHT Eurpoe

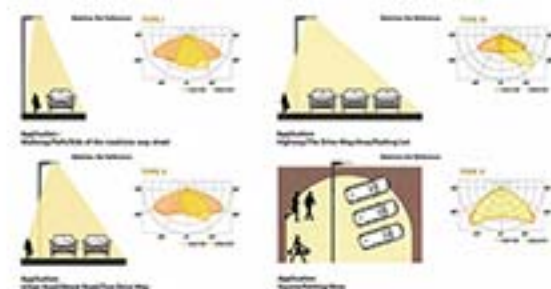

Item No.:AT-STL-/30/50/60/80/100/120/150/180/200/240

Power: 30w / 50w / 60w / 80w / 100w / 120w / 150w / 180w / 200w / 240w  
 Efficiency: 102lm/w ; 105lm/w ; 108lm/w ; 110lm/w  
 Size: 507\*210\*143mm / 616\*259\*186mm / 676\*303\*186mm / 850\*366\*198mm  
 Lens: T1M,T2M,T3M,T4S  
 CCT: 1800K-6500K  
 Dimming: Light sensor switch, microwave/IR sensor, 0/1-10V,DALI 2.0 D4I, PWM, Timer; 4G/LoraWan Smart Control



## LED STREET LIGHT SERIES @LED路灯系列

### AT-YDL LED GARDEN LIGHT

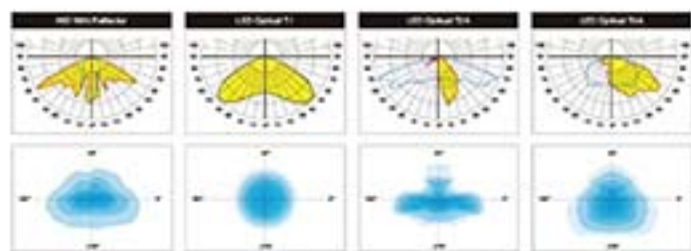
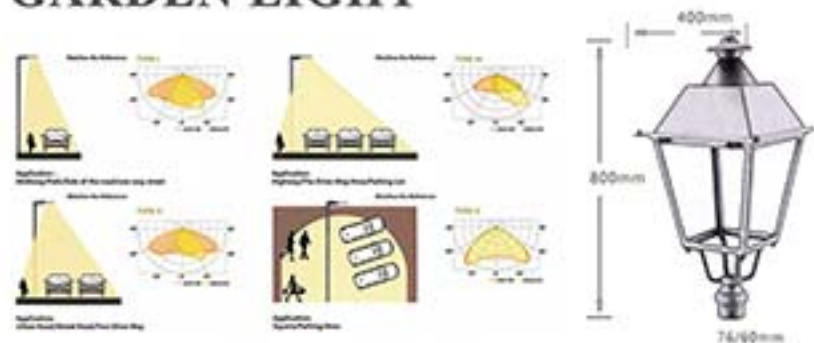

Item No.:AT-YDL-20/40/60/80

Power: 20w / 40w / 60w / 80w

Efficiency: 110lm/w - 140lm/w

Size:  $\Phi 76/60 \times 800 \times 400$ mm

Lens: T1M, T2M, T3M, T4S, T5(90°, 120°)

CCT: 1800K-6500K

Dimming: Light sensor switch, microwave/IR sensor, 0/1-10V, DALI 2.0 D4I, PWM, Timer; 4G/LoraWan Smart Control

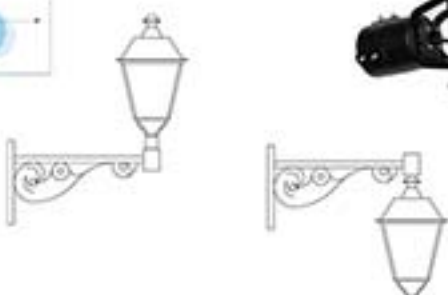

## LED STREET LIGHT SERIES @LED路灯系列

### AT-HGL LED GARDEN LIGHT

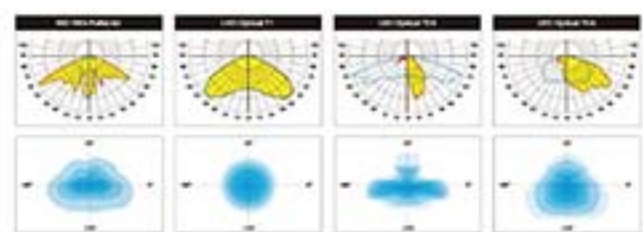
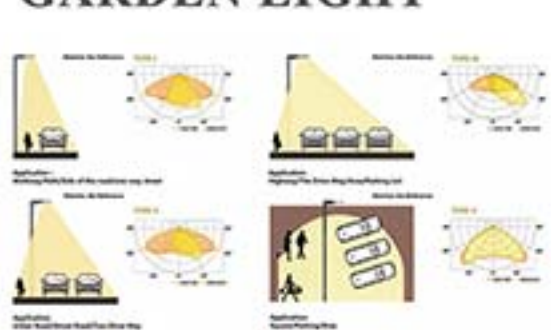

Item No.:AT-HGL-/20/40/60/80

Power: 20w / 40w / 60w / 80w

Efficiency: 110lm/w - 140lm/w

Size:  $\Phi 500 \times \Phi 76 \times 980$ mm

Lens: T1M, T2M, T3M, T4S, T5(90°, 120°)

CCT: 1800K-6500K

Dimming: Light sensor switch, microwave/IR sensor, 0/1-10V, DALI 2.0 D4I, PWM, Timer; 4G/LoraWan Smart Control





LED STREET LIGHT  
SERIES  
@LED路灯系列

AT-KR LED  
GARDEN LIGHT

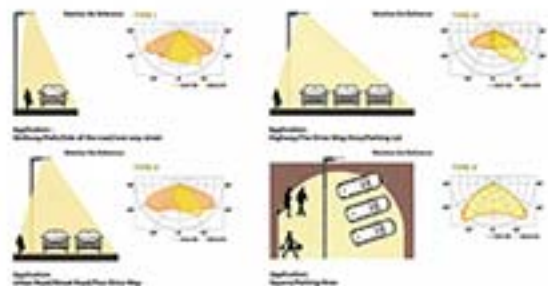
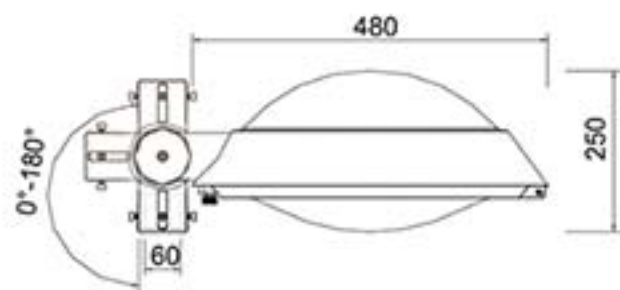

Item No.:AT-KR-20/30/40/50/60/70/80

Power: 20w / 30w / 40w / 50w / 60w / 70w / 80w  
 Efficiency: 110lm/w - 140lm/w  
 Size: 480\*250mm  
 Lens: T1M,T2M,T3M,T4S,T5(90°, 120°)  
 CCT: 1800K-6500K  
 Dimming: Light sensor switch, microwave/IR sensor, 0/1-10V,DALI 2.0 D4I, PWM, Timer; 4G/LoraWan Smart Control



LED STREET LIGHT  
SERIES  
@LED路灯系列

AT-KRK LED  
GARDEN LIGHT

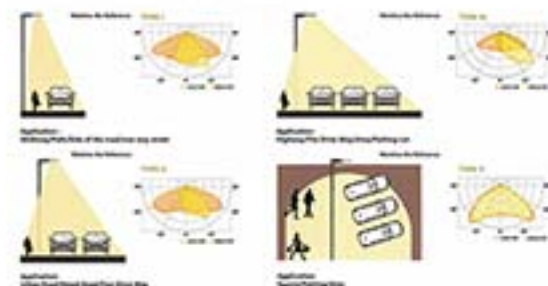
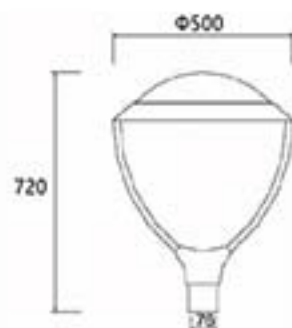

Item No.:AT-KRK-/20/30/40/50/60/70/80

Power: 20w / 30w / 40w / 50w / 60w / 70w / 80w  
 Efficiency: 110lm/w - 140lm/w  
 Size: 500\*720mm  
 Lens: T1M,T2M,T3M,T4S,T5(90°, 120°)  
 CCT: 1800K-6500K  
 Dimming: Light sensor switch, microwave/IR sensor, 0/1-10V,DALI 2.0 D4I, PWM, Timer; 4G/LoraWan Smart Control





LED STREET LIGHT  
SERIES  
@LED路灯系列

AT-SG01 LED  
GARDEN LIGHT

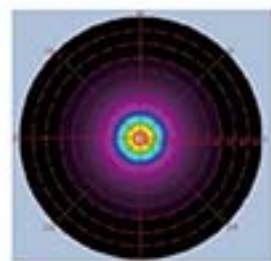
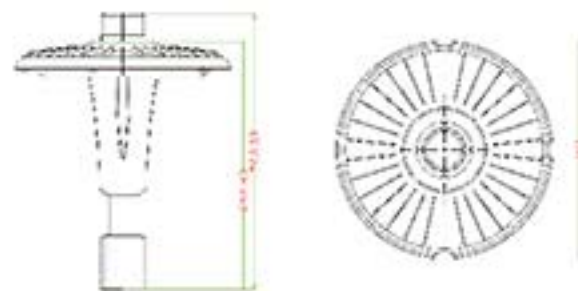

Item No.:AT-SG01-80/100/120/150/200

Power: 80w / 100w / 120w / 150w / 200w

Efficiency: 120lm/w ; 125lm/w ; 130lm/w

Size: 400\*400\*455mm / 446\*446\*456mm

Lens: 120° milkly

CCT: 1800K-6500K

Dimming: Light sensor switch, microwave/IR sensor, 0/1-10V,DALI 2.0 D4I, PWM, Timer; 4G/LoraWan Smart Control



LED STREET LIGHT  
SERIES  
@LED路灯系列

AT-SG02 LED  
GARDEN LIGHT

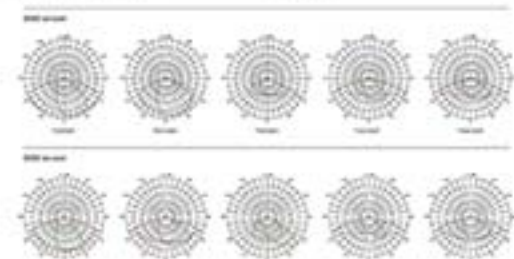
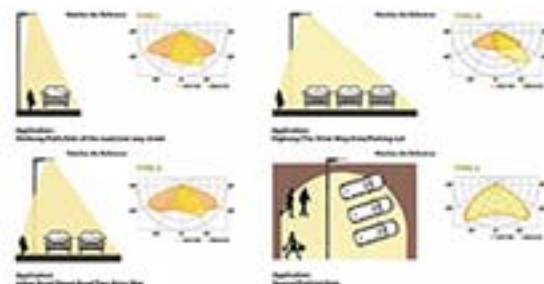

Item No.:AT-SG02-/30/40/50/80/100

Power: 30w / 40w / 50w / 80w / 100w

Efficiency: 150lm/w ; 160lm/w

Size: Ø500\*59mm

Lens: T1S,T2M,T3M,T4S,T5(60°, 90°, 120°)

CCT: 1800K-6500K

Dimming: Light sensor switch, microwave/IR sensor, 0/1-10V,DALI 2.0 D4I, PWM, Timer; 4G/LoraWan Smart Control



LED STREET LIGHT  
SERIES  
@LED路灯系列

AT-SS02 LED  
PROJECTOR LIGHT

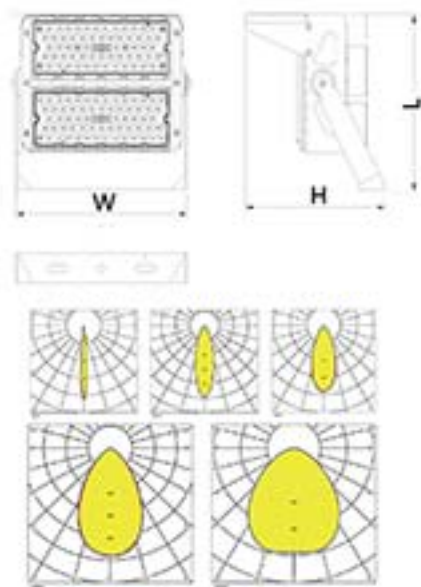

Item No.:AT-SS02-300/400/500/600/800/1000/1200/1500

Power: 300w / 400w / 500w / 600w / 800w / 1000w / 1200w / 1500w

Efficiency: 165lm/w ; 170lm/w

Size: 352\*288\*316mm / 586\*288\*316mm / 360\*405\*647mm / 595\*405\*647mm / 595\*500\*926mm

Lens: 10°, 20°, 40°, 60°, 90°

CCT: 1800K-6500K

Dimming: Light sensor switch, microwave/IR sensor, 0/1-10V,DALI 2.0 D4I, PWM, Timer; 4G/LoraWan Smart Control

LED STREET LIGHT  
SERIES  
@LED路灯系列

AT-SS03 LED  
PROJECTOR LIGHT

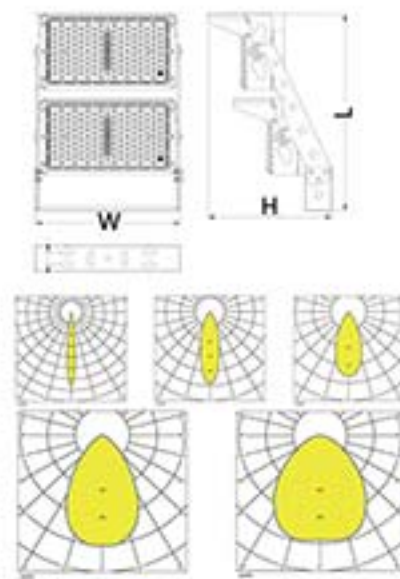

Item No.:AT-SS03-/400/500/800/1000/1200/1500

Power: 400w / 500w / 800w / 1000w / 1200w / 1500w

Efficiency: 140lm/w ; 170lm/w

Size: 465\*288\*316mm / 565\*288\*316mm / 474\*405\*647mm / 565\*405\*647mm / 476\*500\*925mm / 567\*500\*926mm

Lens: 15°, 30°, 45°, 60°, 90°

CCT: 1800K-6500K

Dimming: Light sensor switch, microwave/IR sensor, 0/1-10V,DALI 2.0 D4I, PWM, Timer; 4G/LoraWan Smart Control

LED STREET LIGHT  
SERIES  
@LED路灯系列

AT-PJ9 LED  
PROJECTOR LIGHT

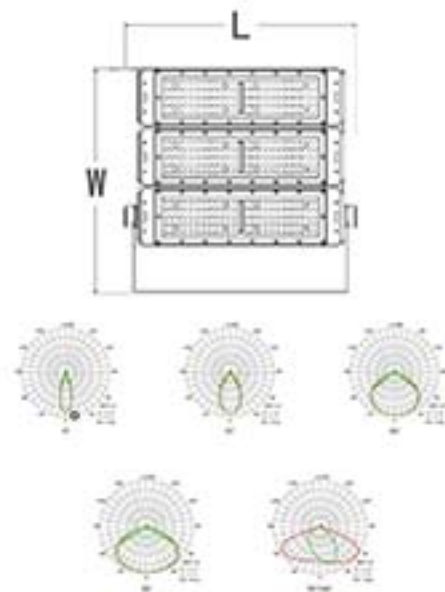

Item No.:AT-PJ9-100/200/300/400/500/600/800/1000/1200

Power: 100w / 200w / 300w / 400w / 500w / 600w / 800w / 1000w / 1200w

Efficiency: 140lm/w

Size: 403\*183\*110mm / 403\*287\*110mm / 403\*391\*110mm / 403\*495\*110mm / 403\*600\*110mm / 403\*703\*110mm  
778\*495\*110mm / 778\*600\*110mm / 778\*703\*110mm

Lens: 15°, 30°, 60°, 90°, 70\*140°

CCT: 1800K-6500K

Dimming: Light sensor switch, microwave/IR sensor, 0/1-10V,DALI 2.0 D4I, PWM, Timer; 4G/LoraWan Smart Control

LED STREET LIGHT  
SERIES  
@LED路灯系列

AT-Tun4 LED  
PROJECTOR LIGHT

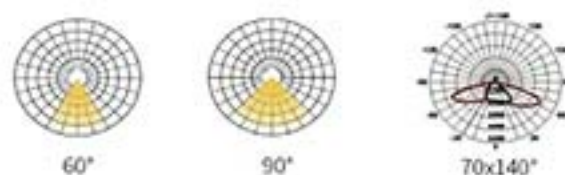
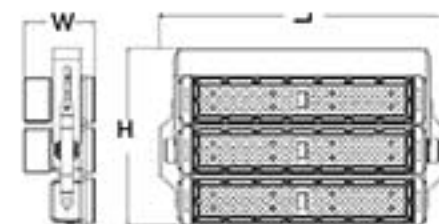

Item No.:AT-Tun4-50/100/150/200/250/300

Power: 50w / 100w / 150w / 200w / 250w / 300w

Efficiency: 140lm/w

Size: 436\*202\*113mm / 436\*282\*113mm / 455\*282\*113mm / 455\*363\*113mm / 455\*443\*113mm / 455\*524\*113mm

Lens: 30°, 60°, 90°, 70\*140°

CCT: 1800K-6500K

Dimming: Light sensor switch, microwave/IR sensor, 0/1-10V,DALI 2.0 D4I, PWM, Timer; 4G/LoraWan Smart Control



LED STREET LIGHT  
SERIES  
@LED路灯系列

AT-Tun4Pro LED  
PROJECTOR LIGHT



Item No.:AT-Tun4Pro-50/100/150/200/250/300

Power: 50w / 100w / 150w / 200w / 250w / 300w

Efficiency: 140lm/w

Size: 436\*202\*113mm / 436\*282\*113mm / 455\*282\*113mm / 455\*363\*113mm / 455\*443\*113mm / 455\*524\*113mm

Lens: 30°, 60°, 90°, 70\*140°

CCT: 1800K-6500K

Dimming: Light sensor switch, microwave/IR sensor, 0/1-10V,DALI 2.0 D4I, PWM, Timer; 4G/LoraWan Smart Control

LED STREET LIGHT  
SERIES  
@LED路灯系列

AT-Tun4Max LED  
PROJECTOR LIGHT



Item No.:AT-Tun4Max-50/100/150/200/250/300

Power: 50w / 100w / 150w / 200w / 250w / 300w

Efficiency: 140lm/w

Size: 436\*202\*113mm / 436\*282\*113mm / 455\*282\*113mm / 455\*363\*113mm / 455\*443\*113mm / 455\*524\*113mm

Lens: 30°, 60°, 90°, 70\*140°

CCT: 1800K-6500K

Dimming: Light sensor switch, microwave/IR sensor, 0/1-10V,DALI 2.0 D4I, PWM, Timer; 4G/LoraWan Smart Control

LED STREET LIGHT  
SERIES  
@LED路灯系列

AT-F08 LED  
FLOOD LIGHT

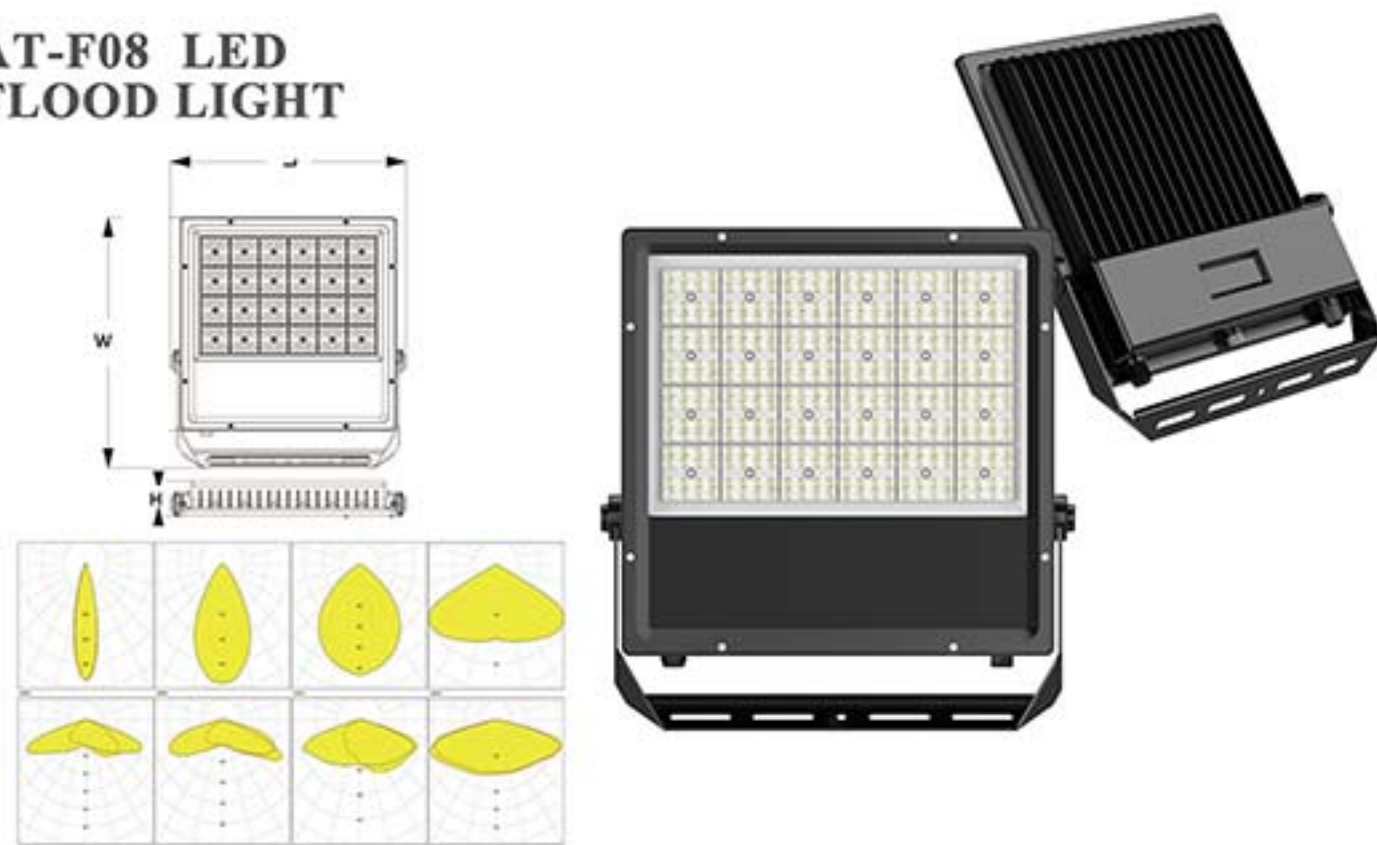

Item No.:AT-F08-30/50/70/100/120/150/180/200/240/300/320/400

Power: 30w / 50w / 70w / 100w / 120w / 150w / 180w / 200w / 240w / 300w / 320w / 400w

Efficiency: 160lm/w, 180lm/w

Size: 312\*207\*53mm / 312\*258\*53mm / 312\*309\*53mm / 362\*309\*53mm / 413\*309\*53mm / 437\*411\*61mm / 510\*437\*61mm

Lens: 30°, 60°, 90°, 120°, T2M, T3M

CCT: 1800K-6500K

Dimming: Light sensor switch, microwave/IR sensor, 0/1-10V,DALI 2.0 D4I, PWM, Timer; 4G/LoraWan Smart Control

LED STREET LIGHT  
SERIES  
@LED路灯系列

AT-F09 LED  
FLOOD LIGHT

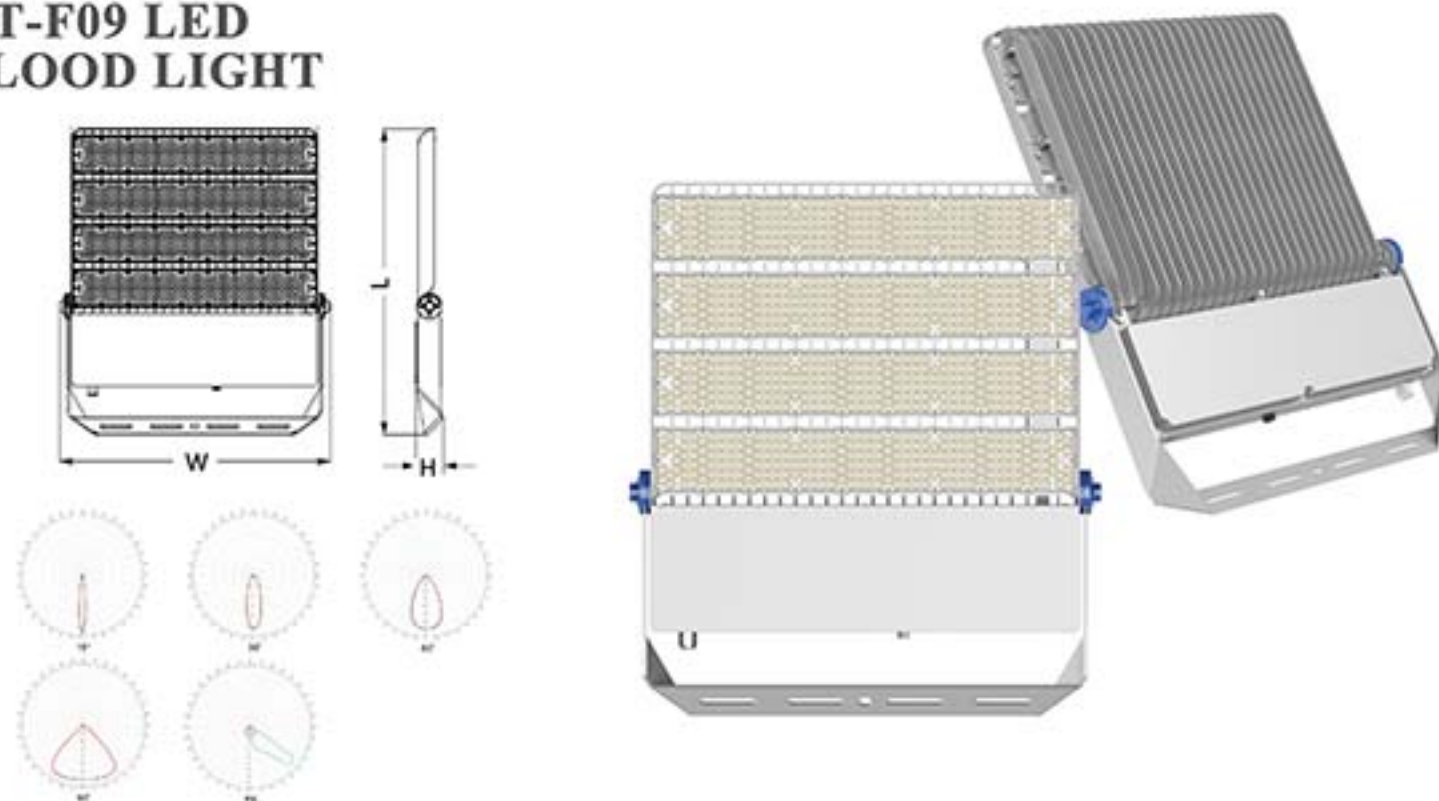

Item No.:AT-F09-400/500/600/750/800/1000

Power: 400w / 500w / 600w / 750w / 800w / 1000w

Efficiency: 180lm/w ; 185lm/w

Size: 589\*474\*60mm / 589\*570\*60mm / 589\*667\*60mm

Lens: 30°/60°/90°/P6

CCT: 1800K-6500K

Dimming: Light sensor switch, microwave/IR sensor, 0/1-10V,DALI 2.0 D4I, PWM, Timer; 4G/LoraWan Smart Control

# 智慧照明

## SMART LIGHTING

### 系列介绍 Series Introduction

随着社会的快发展, AI技术快速进步, IOT技术应用出现在各个行业, 我们致力于各行业解决方案; 研发了智慧路灯管理系统, 智慧太阳能管理系统, 智慧社区系统, 智慧浇灌与洪水预警系统等

With the rapid development of society, AI technology is advancing rapidly and IOT technology applications appear in various industries. We are committed to solutions for various industries; we have developed smart street lamp management systems, smart solar energy management systems, smart community systems, smart irrigation and flood warning systems etc.



## Smart Street Lighting Solution 智慧路灯解决方案

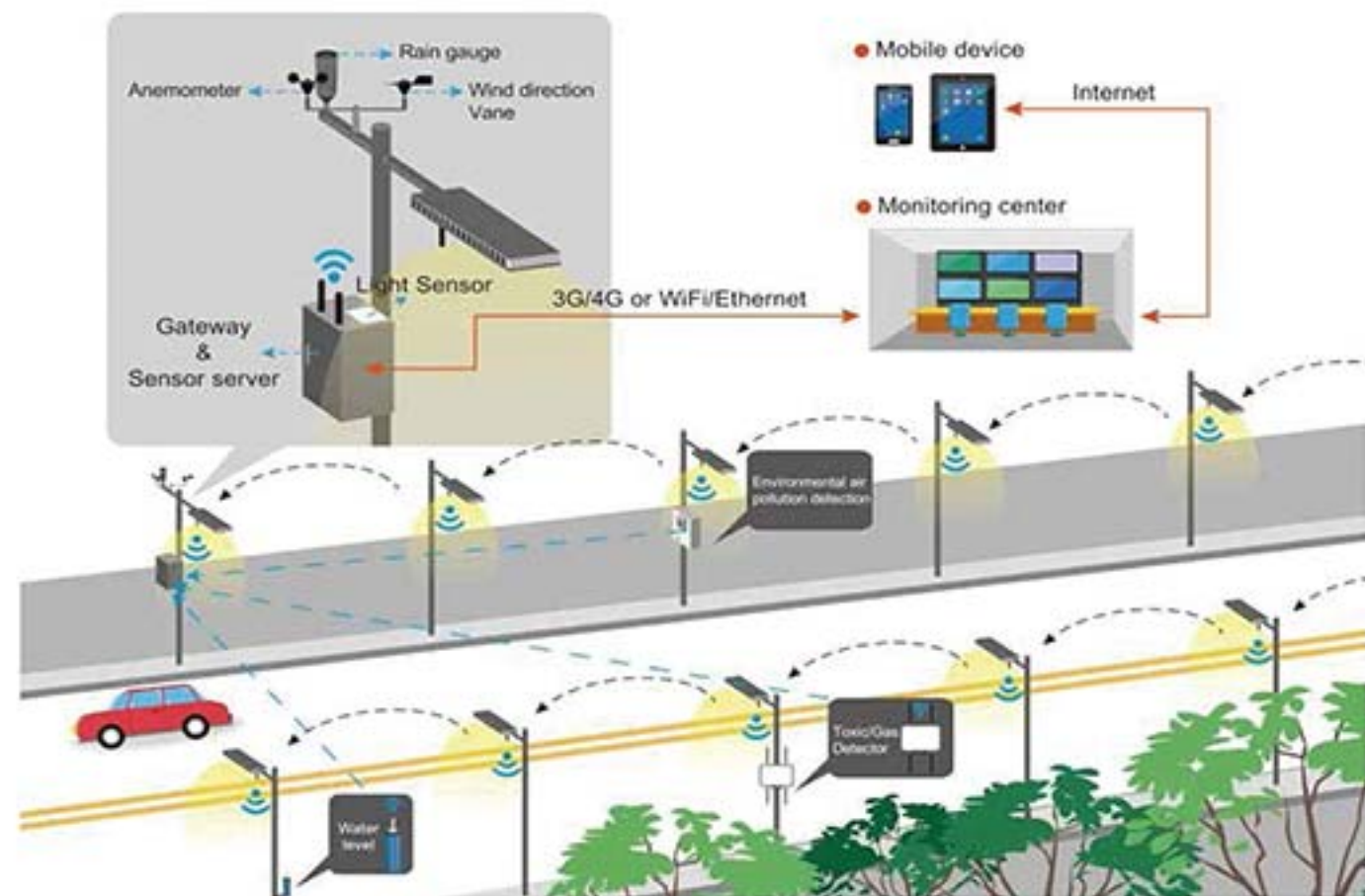

## LoRaWan IOT Architecture Diagram

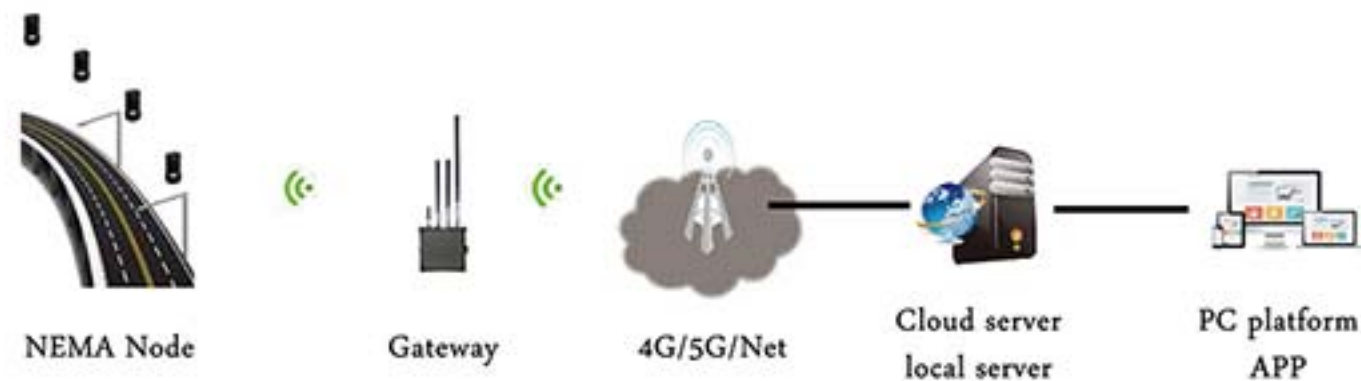

智慧路灯解决方案是一个基于户外街道路灯，通过开关，控制调光，控制策略管理，GIS显示，故障告警，能耗分析，自由编组，监控运维来实现二次节能，数据分析，缩短异常响时间来节省成本并大幅降低路灯运营压力的智慧系统，其具有通过定时调光，经纬度调光感应器调光等多重智慧控制方式，地图管理，快速排除异常等功能。

The smart street light solution is an outdoor street light, through the switch, Control dimming, control strategy management, GIS display, fault alarm, energy consumption analysis, free grouping, monitoring operation and maintenance to achieve secondary energy saving, data analysis, shorten the time of abnormal noise to save costs and greatly reduce the intelligent system of street lamp operation pressure, It has multiple intelligent control methods such as timing dimming, latitude and longitude dimming sensor dimming, map management, and quick troubleshooting.

# SMART CITY IOT SOLUTIONS SERIES

@物联网智慧城市解决方案



Modle: Smacxty-CMN  
Input: AC90-265V  
Means of communication: Lora /Cat1 /NB-IOT /4G  
output: 0-10V or 0-10V/DC5V 400mA/12V 200mA  
Standby power: <0.5W  
Data Collection: U,I,P,Q,W.COS $\Phi$  accuracy : 1%  
Functions: switch light, light control switch, dimming and color adjustment, data collection, abnormal report  
NEMA interface, compatible with standard ANSI C136.41



Modle: Smacxty-CMA  
Input: AC90-265V  
Means of communication: Lora /Cat1 /NB-IOT /4G  
output: 0-10V or 0-10V/DC5V 400mA/12V 200mA  
Standby power: <0.5W  
Data Collection: U,I,P,Q,W.COS $\Phi$  accuracy : 1%  
Functions: switch light, light control switch, dimming and color adjustment, data collection, abnormal report  
IP67 External Antenna



Modle: Smacxty-CMZ  
Input: AC90-265V  
Means of communication: Lora /Cat1 /NB-IOT /4G  
output: 0-10V or 0-10V/DC5V 400mA/12V 200mA  
Standby power: <0.5W  
Data Collection: U,I,P,Q,W.COS $\Phi$  accuracy : 1%  
Functions: switch light, light control switch, dimming and color adjustment, data collection, abnormal report  
Zhaga Book 18 interface

# SMART CITY IOT SOLUTIONS SERIES

@物联网智慧城市解决方案



Smacxty-GII  
LoRaWAN protocol is fully compatible 470/868/923 MHz  
Multiple backhaul channel options-4G/LTE, network port  
Efficient frequency utilization-up to 8/16 upload channels (optional)  
Half duplex or full duplex (optional)  
Individual control, group mode  
AC or POE power supply  
Open field coverage 15Km  
countryside coverage 5Km  
Town coverage 2Km  
IP66



Smacxty-K  
Working voltage: AC230V/400V.  
Frame current rating: 100A.  
Breaking capacity: Ics is 6000A.  
Rated current In: In is 10A, 32A, 40A, 50A, 63A, 80A, 100A.  
Life: Mechanical life is 10,000 times on and off, and electrical life is 4,000 times on and off.  
Overvoltage, undervoltage protection, automatic power-on and switch-on  
Rail installation, terminal block  
RS485 communication, baud rate 9600, address 1-247, or Lora, NB-IOT, Cat-1, 4G



Smacxty-K  
Reference voltage: 3 $\times$ 220V/380V, 3 $\times$ 57.7V/100V, 3 $\times$ 100V  
Voltage measurement range: three-phase 80%Un ~ 120%Un  
Current measurement range:  
Transformer access type: 0.3(1.2)A, 1(2)A, 1.5(6)A, 5(6)A  
Straight-through: 5(20)A, 10(40)A, 15(60)A, 20(80)A  
Accuracy level: active power 0.2S, 0.5S level, 1 level; reactive power level 2  
Starting current:  
Transformer connected meter: 1%In (level 0.2s), 1%In (level 0.5s), 2%In (level 1)  
Straight-through table: 4%Ib (level 1)  
Power consumption: <1.5W, 6VA

## Smart Solar Street Lighting Solution 智慧太阳能路灯解决方案

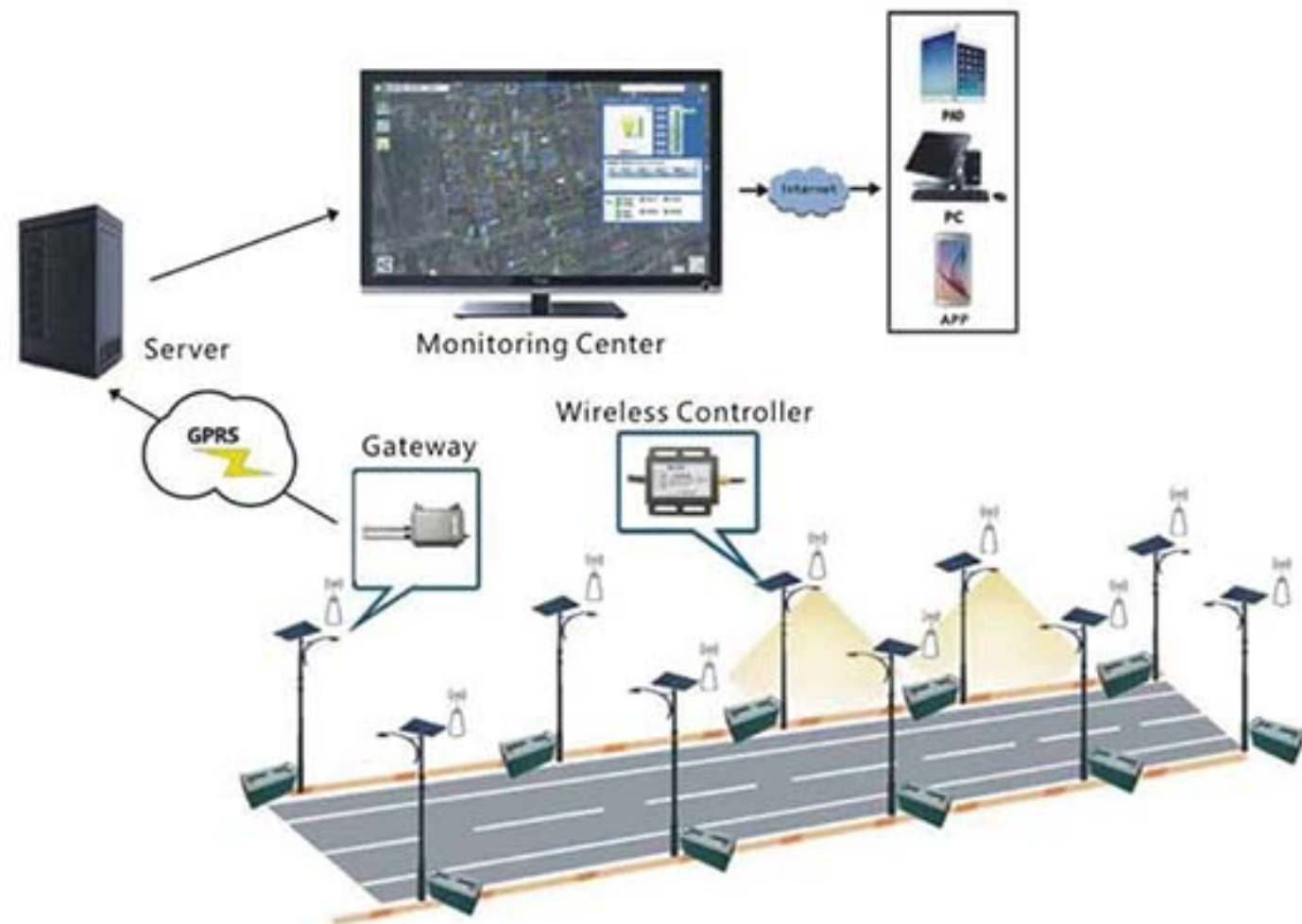

智慧太阳能路灯系统融合光伏发电、储能、无线通信、云计算、物联网、移动互联网、LED照明等技术的集成创新成果，支持公共节能照明系统具备远程控制、主动告警、数据监测、记录查询和智能调控等功能。系统实现了由光伏可再生能源供电的公共照明的信息化和智能化管理，达到降低使用运维成本和节能减碳的效果，是智慧城市建设和新能源应用相结合的典型示范。

The smart solar street light system integrates the integrated innovation achievements of photovoltaic power generation, energy storage, wireless communication, cloud computing, Internet of Things, mobile Internet, LED lighting and other technologies, and supports public energy-saving lighting systems with remote control, active alarm, data monitoring, record query and intelligent control and other functions. The system realizes the informatization and intelligent management of public lighting powered by photovoltaic renewable energy, and achieves the effect of reducing operation and maintenance costs and energy saving and carbon reduction. It is a typical demonstration of the combination of smart city construction and new energy applications.



Model: Smacxy-CMS  
Using MovingTrack MPPT technology  
Using UltraGreen power control technology  
Battery multi-stage constant voltage charging with temperature compensation;  
10-period programmable load power/time control;  
Battery charge and discharge high and low temperature protection, with operating temperature settable;  
Multiple protections : battery/PV reverse polarity protection, LED short-circuit/open-circuit/limited power protection  
Means of communication: Lora /Cat1 /NB-IOT /4G  
IP67

## Intelligent agricultural solutions 智慧农业浇灌解决方案

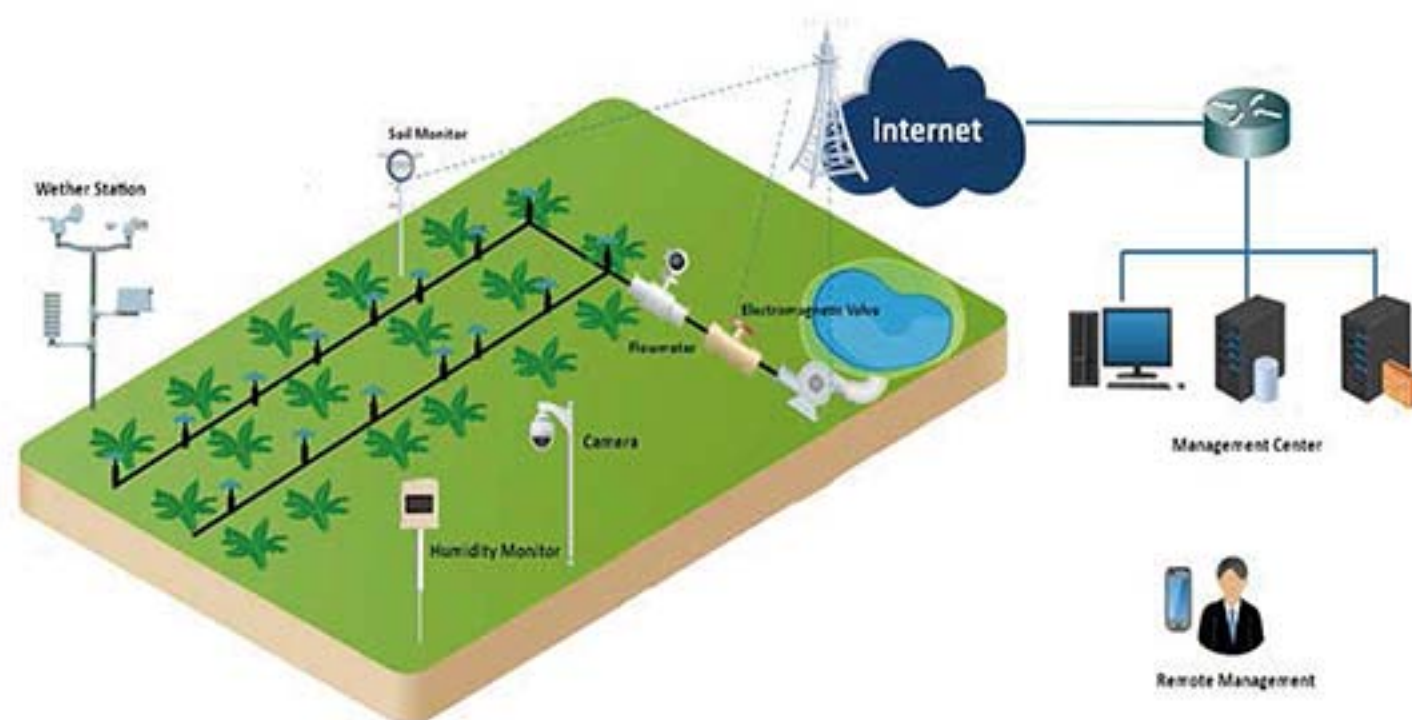

智慧农业系统提供农业大棚温度、湿度、土壤墒情、降雨量、图片抓拍等农业相关数据的采集、传输、存储与计算，并支持GPS、北斗定位。平台利用云存储/云计算等技术，对采集的各种数据进行分析处理，可广泛运用于农产品溯源、农业大棚智能温湿度调节、农田自动灌溉、远程视频专家诊断等场合。

The smart agriculture system provides the collection, transmission, storage and calculation of agriculture-related data such as temperature, humidity, soil moisture, rainfall, and picture capture in agricultural greenhouses, and supports GPS and Beidou positioning. The platform uses cloud storage/cloud computing and other technologies to analyze and process various collected data, which can be widely used in traceability of agricultural products, intelligent temperature and humidity adjustment of agricultural greenhouses, automatic irrigation of farmland, remote video expert diagnosis, etc.



Smacxy-F (solar smart valve)  
LoraWan (Class C), RS485, 4G, Cat1, NB-IoT  
Timer switch, flow control, flow rate measurement,



Smacxy-W (soil moisture temperature monitoring)  
LoraWan (Class C), RS485, Cat1, 4G, NB-IoT  
Monitor soil moisture, temperature

## Smart Flood Early Warning Solution 智慧洪水预警解决方案

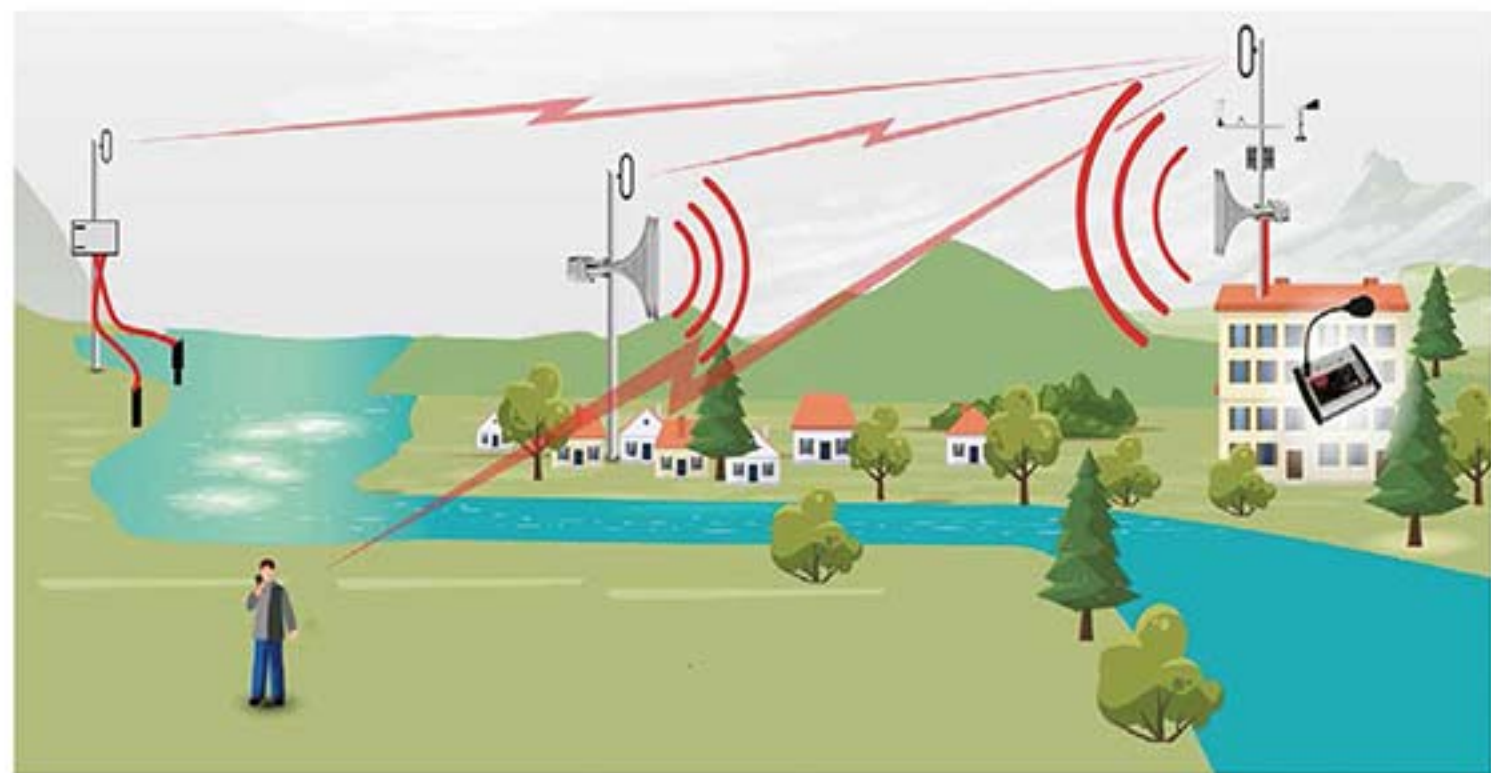

智慧防洪监测预警可视化平台是一种基于互联网和物联网技术的防洪管理系统，通过集成传感器、数据采集和数据分析技术，实现对洪水、水位、水流、降雨等信息的实时监测和管理，对防洪工作进行预测、快速预警通知下游居民游客和有效处置，提高防洪工作的科学性、准确性和可靠性，避免出现人员和财产的损失。

The intelligent flood control monitoring and early warning visualization platform is a flood control management system based on the Internet and Internet of Things technology. By integrating sensors, data collection and data analysis technologies, it can realize real-time monitoring and management of flood, water level, water flow, rainfall and other information. Prediction of work, rapid warning to notify downstream residents and tourists and effective disposal, improve the scientificity, accuracy and reliability of flood control work, and avoid loss of personnel and property.



Smacxty-H (liquid level tester)  
LoraWan (Class C), RS485, Cat1, 4G  
Monitor water level, suitable for fluids, semi-fluids



Smacxty-B (emergency dispersal broadcast)  
Cat1,4G  
Emergency broadcast, suitable for river flooding





# 太阳能照明

## SOLOR LIGHTING

Products show | **ANTSLIT**  
—安量—

### 系列介绍 Series Introduction

独特的设计和工程质量级别的太阳能灯，适用于城市、商业或住宅照明。完整的太阳能灯系列帮助我们的客户节省开发成本，提供更多选择。同时适用于经销商、批发商、项目、零售商。

Unique design and project quality level solar lights which is suitable for urban city, commercial or residential lighting. A complete series of solar light help our clients saving developing costs, provide more options. Meanwhile suitable for distributor, wholesaler, project, retailer.



SOLOR LIGHTING  
SERIES  
@LED太阳能照明系列

AT-DSSL-1 LED  
SOLOR LIGHTING

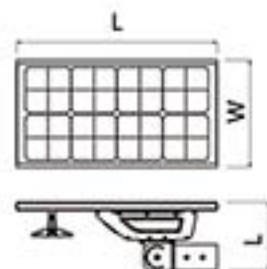

Professional optics



IESNA STANDARD	Beamwidth width / Mounting height	
	One side mounting	Both side mounting
Type I	Up to 1 beam 50%	Up to 2 beam 50%
Type II	Up to 1.5 beam 50%	Up to 3 beam 50%
Type III	Up to 2 beam 50%	Up to 4 beam 50%
Type IV	Up to 4 beam 50%	



Item No.:AT-DSSL-1-30/40/60/80/100/120/150

Power: 30w / 40w / 60w / 80w / 100w / 120w / 150w

Efficiency: 170lm/w

Size: 691\*370\*235mm / 811\*370\*235mm / 1306\*370\*236mm / 1556\*370\*235mm / 1686\*370\*235mm

Lens: T2M

Dimming: Light sensor switch, microwave/IR sensor, 4G/LoraWan Smart Control

CCT: 3000k-6500k

SOLOR LIGHTING  
SERIES  
@LED太阳能照明系列

AT-DSSL-2 LED  
SOLOR LIGHTING

Professional optics



IESNA STANDARD	Beamwidth width / Mounting height	
	One side mounting	Both side mounting
Type I	Up to 1 beam 50%	Up to 2 beam 50%
Type II	Up to 1.5 beam 50%	Up to 3 beam 50%
Type III	Up to 2 beam 50%	Up to 4 beam 50%
Type IV	Up to 4 beam 50%	



Item No.:AT-DSSL-2-40/50/60/80/100/120/150

Power: 40w / 50w / 60w / 80w / 100w / 120w / 150w

Efficiency: 170lm/w

Size: 775\*360\*150 / 1050\*360\*150 / 1235\*360\*150mm / 1505\*360\*150mm / 1665\*360\*150mm / 1855\*370\*150mm

Lens: T2M

Dimming: Light sensor switch, microwave/IR sensor, 4G/LoraWan Smart Control

CCT: 3000k-6000k

# SOLOR LIGHTING SERIES

@LED太阳灯照明系列

## AT-AIO LED SOLOR LIGHTING



Professional optics



IESNA STANDARD	Beamwidth with mounting height	
	One side mounting	Both side mounting
Type I	Up to 1.5 times H <sub>0</sub>	Up to 2 times H <sub>0</sub>
Type II	Up to 1.5 times H <sub>0</sub>	Up to 2 times H <sub>0</sub>
Type III	Up to 2 times H <sub>0</sub>	Up to 3 times H <sub>0</sub>
Type IV	Up to 2 times H <sub>0</sub>	Up to 3 times H <sub>0</sub>

Item No.:AT-AIO-30/60

Power: 30w / 60w  
 Efficiency: 195lm/w ; 3000lm  
 Carton Size: 730\*260\*98mm / 1010\*260\*98mm  
 Lens: T2M  
 Dimming: Light sensor switch, microwave/IR sensor, 4G/LoraWan Smart Control  
 CCT: 6500k

# SOLOR LIGHTING SERIES

@LED太阳能照明系列

## AT-SF01 LED SOLOR LIGHTING

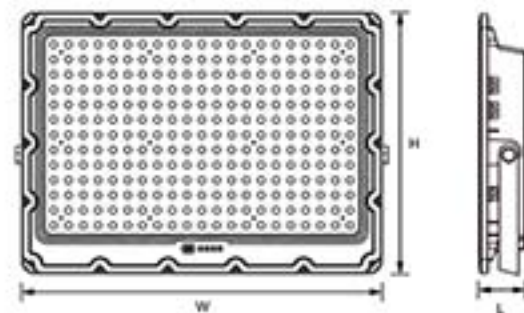

Professional optics

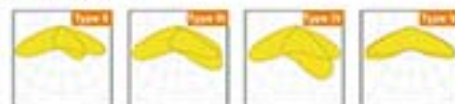

IESNA STANDARD	Beamwidth with mounting height	
	One side mounting	Both side mounting
Type I	Up to 1.5 times H <sub>0</sub>	Up to 2 times H <sub>0</sub>
Type II	Up to 1.5 times H <sub>0</sub>	Up to 2 times H <sub>0</sub>
Type III	Up to 2 times H <sub>0</sub>	Up to 3 times H <sub>0</sub>
Type IV	Up to 2 times H <sub>0</sub>	Up to 3 times H <sub>0</sub>

Item No.:AT-SF01-50/100/200/300/400/500

Power: 50w / 100w / 200w / 300w / 400w / 500w  
 Efficiency: 175lm/w  
 Size: 175\*220\*45mm / 199.5\*274\*45mm / 254.5\*351\*45mm / 301\*421\*45mm  
 Lens: 120°  
 Dimming: Light sensor switch, Smart timer  
 CCT: 3000k-6500k



# SOLOR LIGHTING SERIES

@LED太阳灯照明系列

## AT-SF02 LED SOLOR LIGHTING

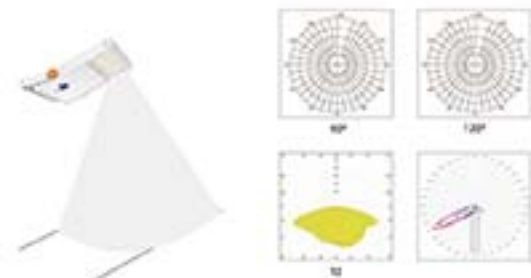
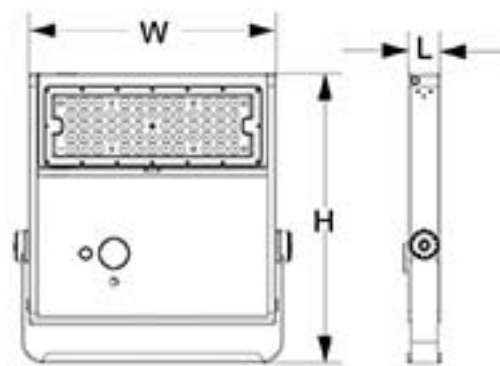

Item No.:AT-SF02-20/30/40/50/60

Power: 20w / 30w / 40w / 50w / 60w

Efficiency: 185lm/w

Size: 460\*400\*50mm / 570\*400\*50mm / 680\*400\*50mm / 880\*400\*50mm / 1070\*400\*50mm

Lens: T2M

Dimming: Light sensor switch, microwave/IR sensor, 4G/LoraWan Smart Control

CCT: 3000K / 4000K / 6000K



## AT-ZTD-235-FZ-T/S LED SOLOR LIGHTING

AT-ZTD-235-FZ-T    AT-ZTD-235-FZ-S

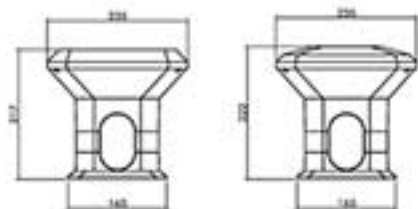

### Item No.:AT-ZTD-235-FZ-T

Solar panels: 5V/4.5W  
Battery: 3.2V /8000mAh  
Quantity of LED chips: 30PCS  
LCharge time: 3-5H

### Item No.:AT-ZTD-235-FZ-S

Voltage:AC220V    POWER:10W

Colour temperature: 3000-6500K  
Waterproof grade: IP65  
Material quality: Aluminum+PC  
Size: 235\*165\*H217/222mm



## AT-CPD-235-FZ-T/S LED SOLOR LIGHTING

AT-CPD-235-FZ-T    AT-CPD-235-FZ-S



### Item No.:AT-CPD-235-FZ-T

Solar panels: 5V/4.5W  
Battery: 3.2V /8000mAh  
Quantity of LED chips: 30PCS  
LCharge time: 3-5H

### Item No.:AT-CPD-235-FZ-S

Voltage:AC220V    POWER:10W

Colour temperature: 3000-6500K  
Waterproof grade: IP65  
Material quality: Aluminum+PC  
Size: 235\*165\*H807/812/400mm



SOLOR LIGHTING  
SERIES  
@LED太阳灯照明系列

AT-BD-235-FZ-T/S LED  
SOLOR LIGHTING

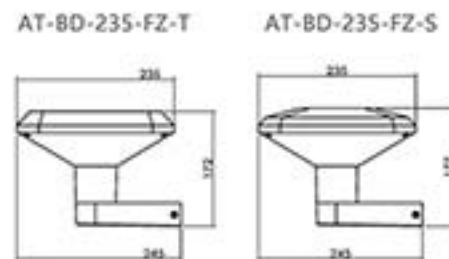

Item No.:AT-BD-235-FZ-T

Solar panels: 5V/4.5W  
Battery: 3.2V /8000mAh  
Quantity of LED chips: 30PCS  
LCharge time: 3-5H

Item No.:AT-BD-235-FZ-S  
Voltage:AC220V POWER:10W

Colour temperature: 3000-6500K  
Waterproof grade: IP65  
Material quality: Aluminum+PC  
Size: 235\*245\*H172/177mm



SOLOR LIGHTING  
SERIES  
@LED太阳能照明系列

AT-TYD-480-FZ-T/S LED  
SOLOR LIGHTING

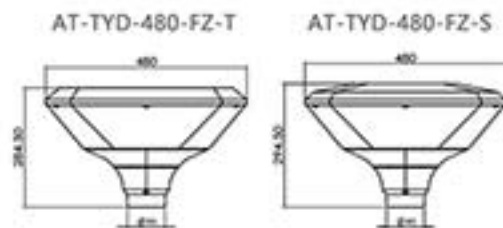

Item No.:AT-TYD-480-FZ-T

Solar panels: 5V/20W  
Battery: 3.2V/20000mAh  
Quantity of LED chips: 160PCS  
LCharge time: 3-5H

Item No.:AT-TYD-480-FZ-S  
Voltage:AC220V POWER:50W

Colour temperature: 3000-6500K  
Waterproof grade: IP65  
Material quality: Aluminum+PC  
Size: 480\*90\*H285/294mm



## AT-ZTD-260-YY-T/S LED SOLOR LIGHTING

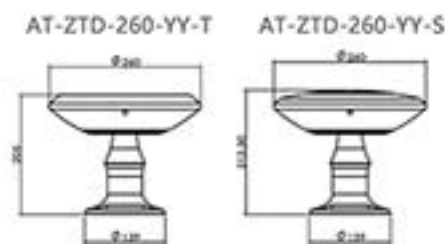

### Item No.:AT-ZTD-260-YY-T

Solar panels: 5V/4.5W  
Battery: 3.2V /8000mAh  
Quantity of LED chips: 30PCS  
LCharge time: 3-5H

### Item No.:AT-ZTD-260-YY-S Voltage:AC220V POWER:10W

Colour temperature: 3000-6500K  
Waterproof grade: IP65  
Material quality: Aluminum+PC  
Size:  $\Phi 260 \times \Phi 139 \times H205/213\text{mm}$



## AT-CPD-YY-T/S LED SOLOR LIGHTING

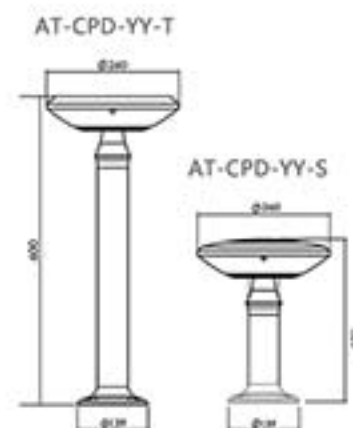

### Item No.:AT-CPD-YY-T

Solar panels: 5V/4.5W  
Battery: 3.2V/8000mAh  
Quantity of LED chips: 30PCS  
LCharge time: 3-5H

### Item No.:AT-CPD-YY-S Voltage:AC220V POWER:10W

Colour temperature: 3000-6500K  
Waterproof grade: IP65  
Material quality: Aluminum+PC  
Size:  $\Phi 260 \times \Phi 139 \times H600/400\text{mm}$





SOLOR LIGHTING  
SERIES  
@LED太阳灯照明系列

AT-BD-260-YY-T/S LED  
SOLOR LIGHTING

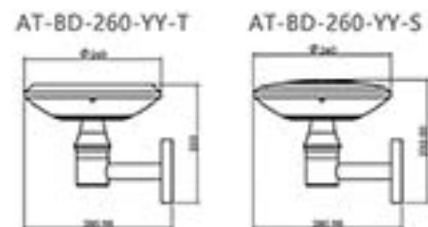

Item No.:AT-BD-260-YY-T

Solar panels: 5V/4.5W  
Battery: 3.2V /8000mAh  
Quantity of LED chips: 30PCS  
LCharge time: 3-5H

Item No.:AT-BD-260-YY-S  
Voltage:AC220V POWER:10W

Colour temperature: 3000-6500K  
Waterproof grade: IP65  
Material quality: Aluminum+PC  
Size:  $\Phi 260 \times 280 \times H225/233$ mm



SOLOR LIGHTING  
SERIES  
@LED太阳能照明系列

AT-TYD-536-YY-T/S LED  
SOLOR LIGHTING

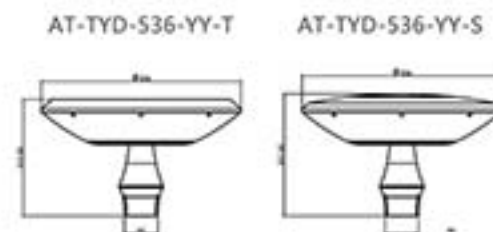

Item No.:AT-TYD-536-YY-T

Solar panels: 5V/4.5W  
Battery: 3.2V/20000mAh  
Quantity of LED chips: 160PCS  
LCharge time: 3-5H

Item No.:AT-TYD-536-YY-S  
Voltage:AC220V POWER:50W

Colour temperature: 3000-6500K  
Waterproof grade: IP65  
Material quality: Aluminum+PC  
Size:  $\Phi 536 \times \Phi 90 \times H327/312$ mm

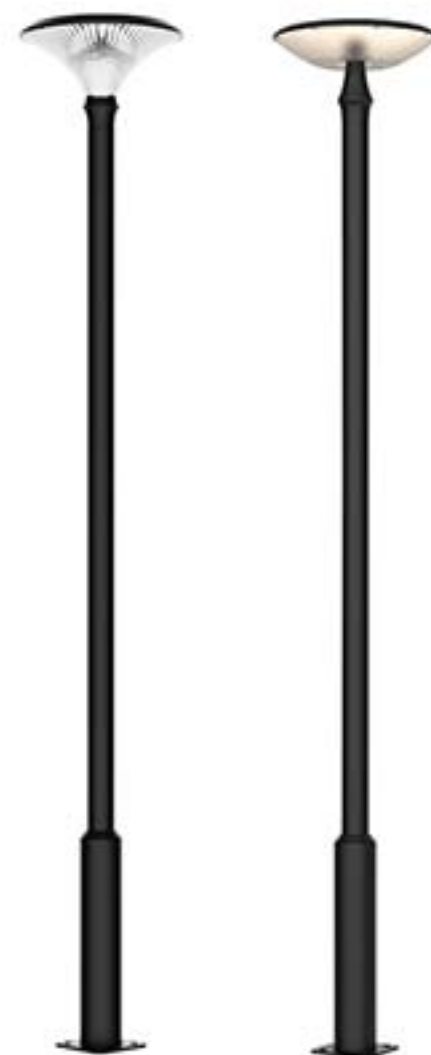

SOLOR LIGHTING  
SERIES  
@LED太阳灯照明系列

AT-SGL-Windows LED  
SOLOR LIGHTING

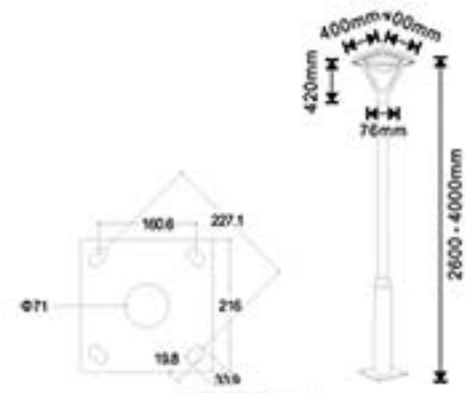

Item No.:AT-SGL-Windows-20

Solar panels: 5V/20W  
Battery: 3.2V /20000mAh  
Colour temperature: 3000-6500K  
LCharge time: 3-5H  
Waterproof grade: IP65  
Material quality: Aluminum+PC  
Size: 400\*400\*H420mm

SOLOR LIGHTING  
SERIES  
@LED太阳能照明系列

AT-SGL-Moonlight LED  
SOLOR LIGHTING

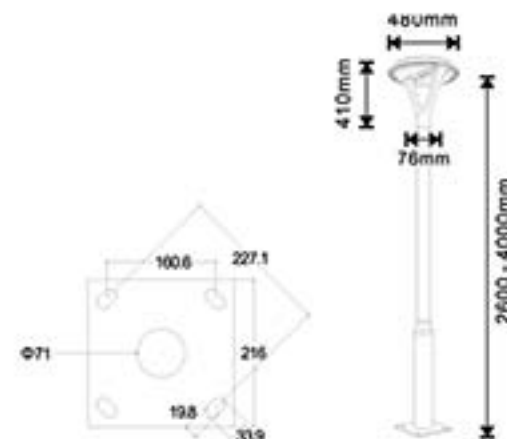

Item No.:AT-SGL-Moonlight

Solar panels: 5V/20W  
Battery: 3.2V /20000mAh  
Colour temperature: 3000-6500K  
LCharge time: 3-5H  
Waterproof grade: IP65  
Material quality: Aluminum+PC  
Size: 480\*H410mm

SOLOR LIGHTING  
SERIES  
@LED太阳灯照明系列

AT-SGL-04-30W LED  
SOLOR LIGHTING

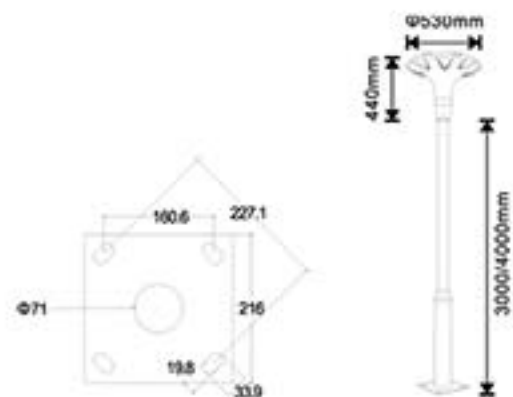

Item No.:AT-SGL-04-30W

Solar panels: 5V/25W  
Battery: 3.2V /30000mAh  
Colour temperature: 3000-6500K  
LCharge time: 3-5H  
Waterproof grade: IP65  
Material quality: Aluminum+PC  
Size: Ø530\*H440mm

SOLOR LIGHTING  
SERIES  
@LED太阳能照明系列

AT-SGL-03 LED  
SOLOR LIGHTING

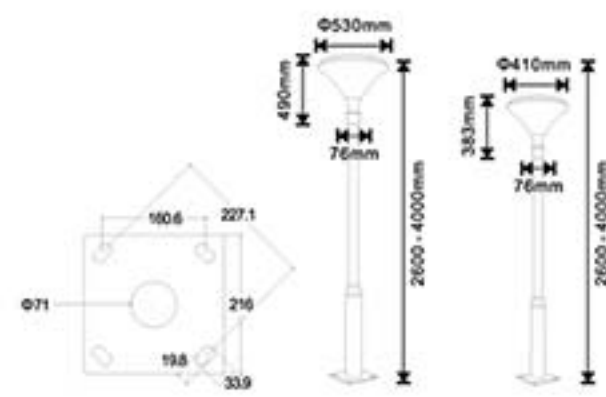

Item No.:AT-SGL-03

Model: AT-SGL-03-20W; AT-SGL-03-30W  
Solar panels: 5V/16W; 5V/25W  
Battery: 3.2V /16000mAh; 3.2V /30000mAh  
Colour temperature: 3000-6500K  
LCharge time: 3-5H  
Waterproof grade: IP65  
Material quality: Aluminum+PC  
Size: 410\*H383mm; 530\*H490mm

SOLOR LIGHTING  
SERIES  
@LED太阳灯照明系列

AT-SGL-Spiral-20W LED  
SOLOR LIGHTING

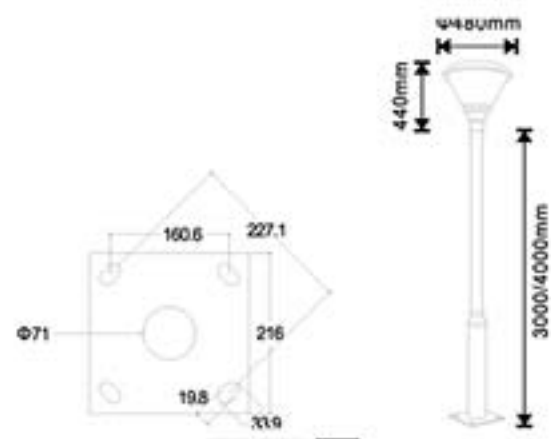

Item No.:AT-SGL-Spiral-20W

Solar panels: 5V/20W  
Battery: 3.2V /20000mAh  
Colour temperature: 3000-6500K  
LCharge time: 3-5H  
Waterproof grade: IP65  
Material quality: Aluminum+PC  
Size: Ø480\*H440mm

AT-SGL-Skylight LED  
SOLOR LIGHTING

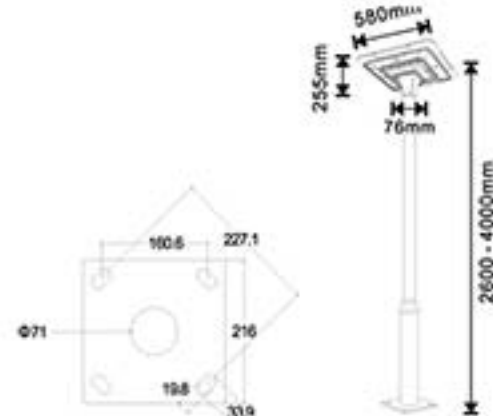

Item No.:AT-SGL-Skylight

Solar panels: 5V/45W  
Battery: 3.2V /60000mAh  
Colour temperature: 3000-6500K  
LCharge time: 3-5H  
Waterproof grade: IP65  
Material quality: Aluminum+PC  
Size: 580\*580\*H255mm

SOLOR LIGHTING  
SERIES  
@LED太阳能照明系列

SOLOR LIGHTING  
SERIES  
@LED太阳灯照明系列

AT-SGL-07-80W LED  
SOLOR LIGHTING



Item No.:AT-SGL-07-80W

Solar panels: 5V/20W  
Battery: 3.2V /45000mAh  
Colour temperature: 3000-6500K  
LCharge time: 3-5H  
Waterproof grade: IP65  
Material quality: Aluminum+PC  
Size: 560\*560\*H230mm

SOLOR LIGHTING  
SERIES  
@LED太阳能照明系列

AT-SGL-02 LED  
SOLOR LIGHTING



Item No.:AT-SGL-02

Model: AT-SGL-02-12W; AT-SGL-02-20W  
Solar panels: 5V/12W; 5V/20W  
Battery: 3.2V /12000mAh; 3.2V /20000mAh  
Colour temperature: 3000-6500K  
LCharge time: 3-5H  
Waterproof grade: IP65  
Material quality: Aluminum+PC  
Size: 320\*320\*H320mm; 400\*400\*H410mm

# 定制照明

## CUSTOMIZED LIGHTING

### 系列介绍 Series Introduction

安腾照明的卓越LED照明产品已为全球数以千计的设计师、建筑师和工程师提供了创作灵感。我们主要产品包括LED路灯、LED玉米灯、LED庭院灯、LED替代灯具、LED高杆灯、LED工矿灯、LED三防灯等。所有产品均可定制智能化控制，例如红外遥控、定时、WIFI控制、蓝牙控制、Dali (D4i)、LoRaWan、ZigBee等。欢迎ODM/OEM!

ANTSLIT's outstanding LED lighting products have provided inspiration for thousands of designers, architects, and engineers worldwide. In the field of road lighting, we collaborate closely with our clients, actively exploring the best solutions based on LED technology. Our main products include LED street lights, LED corn lights, LED courtyard lights, LED replacement luminaires, LED high pole lights, LED industrial lights, LED three-proof lights, etc. All products can be customized for intelligent control, such as infrared remote control, timing, WiFi control, Bluetooth control, Dali(D4i), LoRaWan, ZigBee, etc. ODM/OEM are welcome!

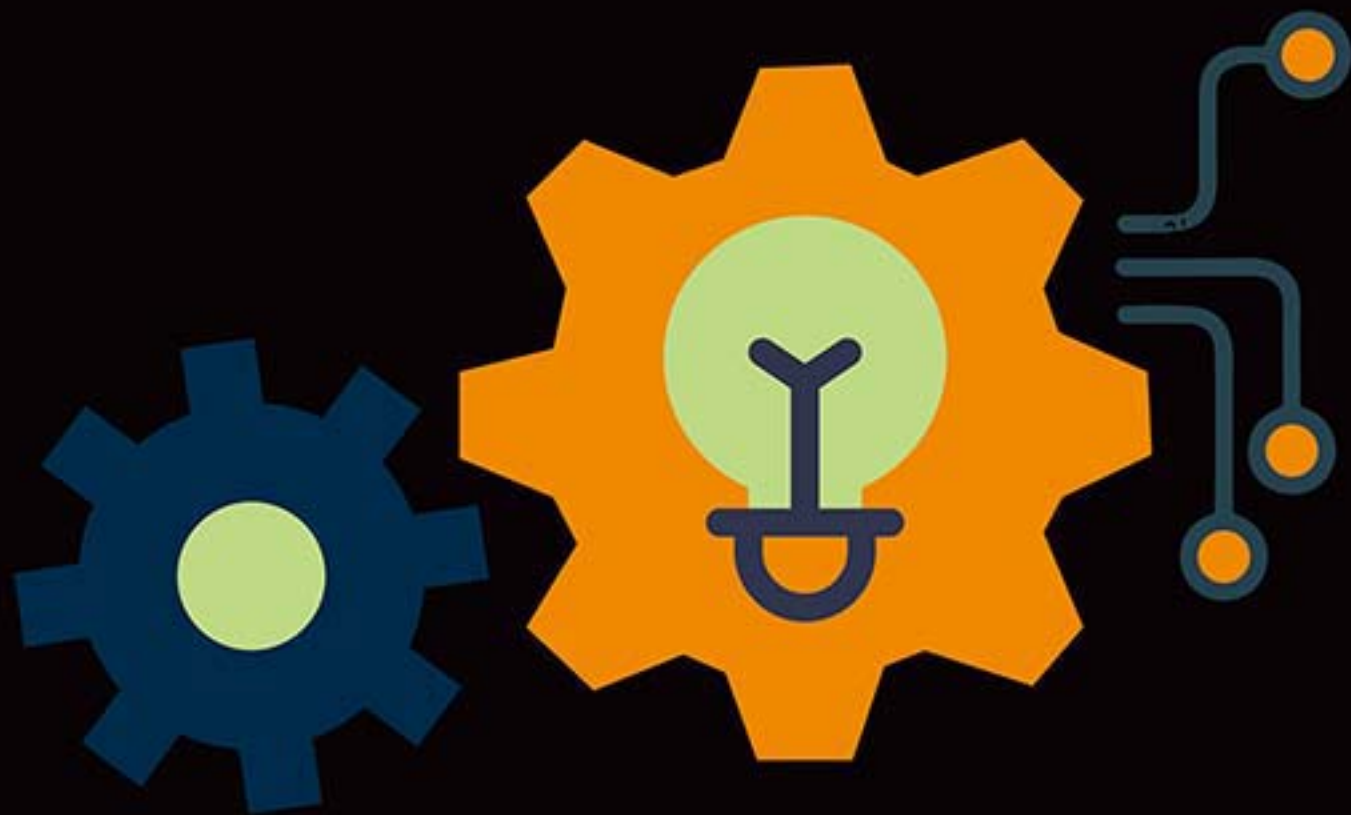



• ANTS ELECTRONICS LIMITED •

**ODM/OEM ARE  
WELCOME!**

WE LOOK FORWARD TO WORKING HAND IN HAND  
WITH YOU TO CREATE A BRIGHT FUTURE.

